

Operating and Programming Manual

HP 8153A Lightwave Multimeter

SERIAL NUMBERS

This manual applies to all instruments with Serial No. 2946G00476 and higher.



HP Part No. 08153-90011
Printed in the Federal Republic of Germany

Third Edition
E1094

Notices

This document contains proprietary information which is protected by copyright. All rights are reserved.

No part of this document may be photocopied, reproduced, or translated to another language without the prior written consent of Hewlett-Packard GmbH.

© Copyright 1992 by:
Hewlett-Packard GmbH
Herrenberger Str. 130
7030 Boeblingen
Federal Republic of Germany

Subject Matter

The information in this document is subject to change without notice.

Hewlett-Packard makes no warranty of any kind with regard to this printed material, including, but not limited to, the implied warranties of merchantability and fitness for a particular purpose.

Hewlett-Packard shall not be liable for errors contained herein or for incidental or consequential damages in connection with the furnishing, performance, or use of this material.

Printing History

New editions are complete revisions of the manual. Update packages, contain additional and replacement information to be incorporated into the manual by the customer. The date on the title page only changes when a new manual is published. When an edition is reprinted, all the prior updates to the edition are incorporated.

Warranty

This Hewlett-Packard instrument product is warranted against defects in material and workmanship for a period of one year from date of shipment. During the warranty period, HP will, at its option, either repair or replace products which prove to be defective.

For warranty service or repair, this product must be returned to a service facility designated by HP. Buyer shall prepay shipping charges to HP and HP shall pay shipping charges to return the product to Buyer. However, Buyer shall pay all shipping charges, duties, and taxes for products returned to HP from another country.

HP warrants that its software and firmware designated by HP for use with an instrument will execute its programming instructions when properly installed on that instrument. HP does not warrant that the operation of the instrument, software, or firmware will be uninterrupted or error free.

Limitation of Warranty

The foregoing warranty shall not apply to defects resulting from improper or inadequate maintenance by Buyer, Buyer-supplied software or interfacing, unauthorized modification or misuse, operation outside of the environmental specifications for the product, or improper site preparation or maintenance.

No other warranty is expressed or implied. Hewlett-Packard specifically disclaims the implied warranties of Merchantability and Fitness for a Particular Purpose.

Exclusive Remedies

The remedies provided herein are Buyer's sole and exclusive remedies. Hewlett-Packard shall not be liable for any direct, indirect, special, incidental, or consequential damages whether based on contract, tort, or any other legal theory.

Assistance

Product maintenance agreements and other customer assistance agreements are available for Hewlett-Packard products. For any assistance contact your nearest Hewlett-Packard Sales and Service Office. Addresses are provided at the back of this manual.

Certification

Hewlett-Packard Company certifies that this product met its published specifications at the time of shipment from the factory.

Hewlett-Packard further certifies that its calibration measurements are traceable to the United States National Institute of Standards and Technology, NIST (formerly the United States National Bureau of Standards, NBS) to the extent allowed by the Institutes's calibration facility, and to the calibration facilities of other International Standards Organization members.

Customer Comment Card

HP 8153A Lightwave Multimeter Operating and Programming Manual

Part No.: 08153-90011

We welcome your evaluation of this manual. Your comments and suggestions will help us improve our publications. Attach additional pages if necessary.

Please circle the following Yes or No:

- | | | |
|--|-----|----|
| ■ Is this manual well organized? | Yes | No |
| ■ Is the information technically accurate? | Yes | No |
| ■ Are instructions complete? | Yes | No |
| ■ Are concepts and wording easy to understand? | Yes | No |
| ■ Are the examples and pictures helpful? | Yes | No |
| ■ Are there enough examples and pictures? | Yes | No |

Additional Comments: _____

Please provide:

Name: _____ Title: _____

Company: _____ Address: _____

City: _____ State: _____ Zip Code/Country _____



Just remove this card, fold so that the pre-addressed label is on the outside, secure and mail.

Thank you for your assistance.

Printed in Germany 1994

Tape here

PLEASE DO NOT STAPLE

Tape here

...Fold here.....Fold here....



Hewlett-Packard GmbH
BID Marketing PL3E
Herrenberger Straße 130
71034 Boeblingen

GERMANY

Control Serial Number: First Edition applies directly to all instruments. First Edition : 1st May 1990 : 08153-90011 : E0590
Second Edition : 1st November 1990 : 08153-90011 : E1191
: 1st April 1992 : 08153-90011 : E0492
: 1st November 1992 : 08153-90011 : E1192
: 1st Decamber 1993 : 08153-90011 : E1293
Third Edition : 1st October 1994 : 08153-90011 : E1094

Safety Considerations

The Model HP 8153A is a Class 1 instrument (that is, an instrument with an exposed metal chassis directly connected to earth via the power supply cable).

The symbol used to show a protective earth terminal in the instrument is .

Before operation, you should review the instrument and manual, including the red safety page, for safety markings and instructions. You must follow these to ensure safe operation and to maintain the instrument in safe condition.

Some HP 8153A circuits are powered whenever the instrument is connected to the AC power source. To disconnect from the line power, disconnect the power cord either at the rear power-inlet or at the AC line-power source (receptacle). One of these must always be accessible. If the instrument is in a cabinet, it must be disconnected from the line power by the system's line-power switch.

Warning



To avoid hazardous electrical shock, do not perform electrical tests when there are signs of shipping damage to any portion of the outer enclosure (covers, panels, etc.).

Line Power Requirements

The HP 8153A can operate from any single-phase AC power source that supplies between 100V and 240V at a frequency in the range from 40 to 60Hz. The maximum power consumption is 55VA with all options installed.



The fuse used by this instrument is T1A / 250V (slow) (HP Part No. 2110-0007). Changing the fuse should be carried out only by a qualified electrician or by HP service personnel as it is necessary to open the instrument.

Line Power Cable

In accordance with international safety standards, this instrument has a three-wire power cable. When connected to an appropriate AC power receptacle, this cable earths the instrument cabinet. The type of power cable shipped with each instrument depends on the country of destination. Refer to Figure 0-1 for the part numbers of the power cables available.

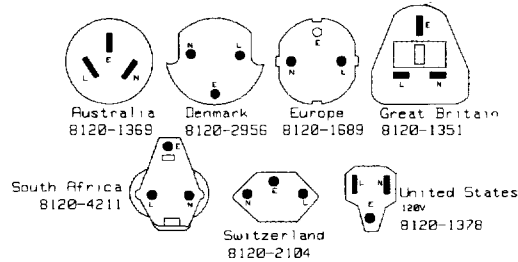

Figure 0-1. Line Power Cables - Plug Identification

Warning



To avoid the possibility of injury or death, you must observe the following precautions before switching on the instrument.

- If this instrument is to be energized via an autotransformer for voltage reduction, ensure that the Common terminal connects to the earthed pole of the power source.
- Insert the power cable plug only into a socket outlet provided with a protective earth contact. Do not negate this protective action by the using an extension cord without a protective conductor.
- Before switching on the instrument, the protective earth terminal of the instrument must be connected to a protective conductor. You can do this by using the power cord supplied with the instrument.
- It is prohibited to interrupt the protective earth connection intentionally.

The following work should be carried out by a qualified electrician, and all local electrical codes must be strictly observed. If the plug on the cable does not fit the power outlet, or if the cable is to be attached to a terminal block, cut the cable at the plug end and rewire it.

The color coding used in the cable depends on the cable supplied. If you are connecting a new plug, it should meet the local safety requirements and include the following features:

- Adequate load-carrying capacity (see table of specifications).
- Ground connection.
- Cable clamp.

Operating Environment

Warning



The HP 8153A is not designed for outdoor use. To prevent potential fire or shock hazard, do not expose the HP 8153A to rain or other excessive moisture.

Input/Output Signals

Caution



A maximum of 15V can be applied as an external voltage to any of the BNC connectors.

Initial Safety Information for Laser Source Modules

The Specifications for these modules are as follows:

	HP 81551MM	HP 81552SM	HP 81553SM	HP 81554SM
Laser Type	FP-Laser InGaAsP	FP-Laser InGaAsP	FP-Laser InGaAsP	Dual FP-Laser InGaAsP
Laser Class				
According to IEC 825 (Europe)	3A	3A	3A	3A
According to 21 CFR 1040.10 (Canada, Japan, USA)	1	1	1	1
Output Power	>-2dBm	>0dBm	>0dBm	>-1dBm
Beam Diameter	50 μ m	9 μ m	9 μ m	9 μ m
Numerical Aperture	0.2	0.1	0.1	0.1
Wavelength	850 \pm 10nm	1310 \pm 20nm	1550 \pm 20nm	1310/1550 \pm 20nm

Note

Canada, Japan, USA

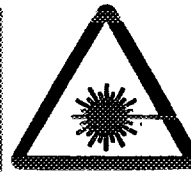

The laser safety warning labels are fixed on the laser module.

Note

Europe

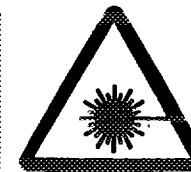
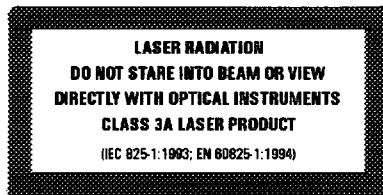

A sheet of laser safety warning labels are included with the laser module. You *MUST* stick the labels in the local language

onto the outside of the mainframe, in a position where they are clearly visible to anyone using the instrument.

You *MUST* return instruments with malfunctioning laser boxes to a HP Service Center for repair and calibration.

The laser module has built in safety circuitry that will disable the optical output in the case of a fault condition.

Warning



Use of controls or adjustments or performance of procedures other than those specified for the laser source may result in hazardous radiation exposure.

Warning



Refer Servicing only to qualified and authorized personnel.

Warning



Do not enable the laser when there is no fiber attached to the optical output connector.

The optical output connector is at the bottom, on the laser module front panel.

The laser is enabled by pressing the grey button above the optical output connector on the front panel. The laser is enabled when the green LED on the front panel of the laser module is lit.

Warning



Under no circumstances look into the end of an optical cable attached to the optical output when the device is operational.

The laser radiation is not visible to the human eye, but it can seriously damage your eyesight.

Contents

1. Getting Started	
The HP 8153A System	1-1
A Quick Overview	1-2
The Keyboard	1-2
Measure Mode	1-2
Menu Mode	1-3
The Display	1-6
A Sample Session	1-8
Hardware Setup	1-8
Switching On and Recalling the Standard Setting	1-8
Making A Power Measurement	1-9
Logging Data	1-11
Examining the Data	1-12
Plotting Data	1-13
2. Measure Mode	
The Chan Key	2-1
The Mode Key	2-1
The Param Key	2-2
Entry Status	2-2
Default Values	2-2
Parameter List	2-2
λ	2-2
CAL	2-3
T	2-3
REF	2-5
ATT	2-6
AUX	2-7
The Disp→Ref Key	2-7
The dB Key	2-8
Using (dB) with a Two Sensor Instrument	2-8
Using (dB) with a One Sensor Instrument	2-9

The dBm/W Key	2-9
The Zero Key	2-9
The N Dig Key	2-11
The Range Keys	2-11
The Auto Key	2-13
The Up Key	2-13
The Down Key	2-13
The Analog Output	2-13
The Modify Keys	2-14
Editing Discrete Valued Parameters	2-14
Editing Continuous Valued Parameters	2-14
Editing Units	2-14

3. Menu Mode

The Chan Key	3-1
The Mode Key	3-1
The System Key	3-2
The Modify Keys	3-2
The Loss Key	3-2
Preparation	3-2
Running the Loss Application	3-3
The Record Key	3-5
Preparation	3-6
The Stability Application	3-7
T_TOTAL	3-8
AUTODUMP	3-8
Running the Stability Application	3-9
The Logging Application	3-9
SAMPLES	3-10
AUTODUMP	3-11
START	3-12
THRESHLD	3-12
Running the Logging Application	3-12
The Manual Logging Application	3-13
Running the Manual Logging Application	3-13
The Plot Application	3-14
AUTOSCAL	3-14
Y_MIN	3-15
Y_MAX	3-15
COMMENT	3-15
Running the Plot Application	3-16

Reading the Plot	3-16
The Print Application	3-18
AUTOSCAL	3-19
Y_MIN	3-19
Y_MAX	3-20
COMMENT	3-20
Running the Print Application	3-21
Reading the Printout	3-21
The MinMax Applications	3-24
MODE	3-25
SAMPLES	3-26
Running the MinMax Application	3-26
The More Key	3-26
The Show Application	3-27
MAXIMUM	3-27
MINIMUM	3-27
DIFF	3-27
AVERAGE	3-27
# 1	3-28
The Alignment Application	3-28
Preparation	3-28
TYPE	3-29
DELTA	3-29
MAXPOWER	3-29
Running the Alignment Application	3-30
4. System Mode	
The Mode Key	4-1
The Modify Keys	4-1
The System Key	4-2
RECALL	4-2
The Module Type	4-3
The Location	4-3
The Channel	4-3
STORE	4-4
The Module Type	4-5
The Channel	4-5
The Location	4-5
HPIB	4-5
ADDRESS	4-5
MODE	4-6

LANGUAGE	4-6
DISPLAY	4-7
BRIGHT	4-7
DATETIME	4-7
MM/DD/YY	4-8
HH:MM:SS	4-8
5. Programming the HP 8153A	
Introduction	5-1
The HP 8153A HP-IB Capabilities	5-2
HP-IB Display Indicators	5-2
The Parser	5-3
Parser Type	5-3
Synchronization	5-3
Clearing the Input Queue	5-4
Accepted Characters	5-4
HP-IB Bus Commands	5-4
HP-IB Priority	5-6
TMSL	5-6
Setting the HP-IB Address	5-8
Syntax Diagram Conventions	5-9
6. Common Commands	
Common Status Information	6-1
SRQ, The Service Request	6-3
Input Queue	6-3
Output Queue	6-3
Error Queue	6-3
*CLS	6-4
*ESE	6-5
*ESE?	6-6
*ESR?	6-6
*IDN?	6-7
*OPC	6-8
*OPC?	6-9
*OPT?	6-9
*RST	6-10
*SRE	6-11
*SRE?	6-12
*STB?	6-13
*TRG	6-14

*TST?	6-14
*WAI	6-14

7. HP-IB Status Commands

The Status Registers	7-1
The Condition Registers	7-2
The Transition Filters	7-2
The Event Registers	7-2
The Enable Registers	7-2
The Status Commands	7-3
STATUS:PRESet	7-3
STATUS:<node>:CONditiOn?	7-4
STATUS:<node>:ENABle	7-5
STATUS:<node>:ENABle?	7-5
STATUS:<node>[:EVENT]t?	7-5
STATUS:<node>:NTRansiOn	7-6
STATUS:<node>:NTRansiOn?	7-6
STATUS:<node>:PTRansiOn	7-6
STATUS:<node>:PTRansiOn?	7-7
The Operation Status	7-7
The Operation Status Commands	7-9
The OPERation node	7-10
The OPERation:SETTling Node	7-11
The OPERation:SETTling:LPELTier Node	7-11
The OPERation:SETTling:HPELTier Node	7-11
The OPERation:MEASuring Node	7-11
The OPERation:MEASuring:POWer Node	7-11
The OPERation:TRIGger Node	7-12
The OPERation:TRIGger:POWer Node	7-12
The OPERation:CORReCting Node	7-12
The OPERation:CORReCting:ZERO Node	7-12
The OPERation:AVERaging Node	7-12
The OPERation:AVERaging:POWer Node	7-12
The OPERation:PROGram Node	7-13
The OPERation:PROGram:<application> Node	7-13
The Questionable Status	7-13
The Questionable Status Commands	7-15
The QUEStionable node	7-16
The QUEStionable:POWer Node	7-17
The QUEStionable:POWer:OVERRange Node	7-17
The QUEStionable:POWer:LCURRent Node	7-17

The QUEStionable:POWer:HCURRent Node	7-18
The QUEStionable:POWer:LMONitor Node	7-18
The QUEStionable:POWer:HMONitor Node	7-18
The QUEStionable:POWer:ENVTemp Node	7-18
The QUEStionable:ISUMmary Node	7-19
The QUEStionable:ISUMmary:INSTrument[1 2] Node	7-19
The QUEStionable:ISUMmary:INSTrument[1 2]:POWer Node	7-19
The Source Status	7-20
The Source Status Commands The following are the source status	7-20
The SOURce node	7-21

8. HP-IB Commands

ABORt Commands	8-1
Specifying the Channel	8-1
ABORt	8-1
DISPlay Commands	8-2
DISPlay:BRIGhtness	8-2
DISPlay:BRIGhtness?	8-2
DISPlay:STATe	8-3
DISPlay:STATe?	8-3
FETCh Commands	8-4
Specifying the Channel	8-4
FETCh[:SCALAr]:POWer[:DC]	8-4
INITiate Commands	8-7
Specifying the Channel	8-7
INITiate:CONTInuous	8-7
INITiate:CONTInuous?	8-7
INITiate[:IMMediate]	8-8
READ Commands	8-8
Specifying the Channel	8-8
READ[:SCALAr]:POWer[:DC]	8-8
SENSE Commands	8-9
Specifying the Channel	8-11
SENSE:CORRection:COLLect:ZERO	8-11
SENSE:CORRection:COLLect:ZERO?	8-11
SENSE:CORRection[:LOSS[:INPut[:MAGNitude]]]	8-11
SENSE:CORRection[:LOSS[:INPut[:MAGNitude]]]?	8-12
SENSE:POWer:ATIME	8-12
SENSE:POWer:ATIME?	8-13
SENSE:POWer:RANGe:AUTO	8-13
SENSE:POWer:RANGe:AUTO?	8-13

SENSE:POWer:RANGe[:UPPER]	8-14
SENSE:POWer:RANGe[:UPPER]?	8-16
SENSE:POWer:REFerence	8-16
SENSE:POWer:REFerence?	8-17
SENSE:POWer:REFerence:DISPlay	8-18
SENSE:POWer:REFerence:STATe	8-19
SENSE:POWer:REFerence:STATe?	8-19
SENSE:POWer:REFerence:STATe:RATIo	8-20
SENSE:POWer:REFerence:STATe:RATIo?	8-20
SENSE:POWer:UNIT	8-21
SENSE:POWer:UNIT?	8-21
SENSE:POWer:WAVElength	8-21
SENSE:POWer:WAVElength?	8-22
SOURce Commands	8-22
Specifying the Channel	8-23
SOURce:AM[:INTErnal]:FREQUency	8-23
SOURce:AM[:INTErnal]:FREQUency?	8-23
SOURce:POWer:ATTenuation	8-24
SOURce:POWer:ATTenuation?	8-24
SOURce:POWer:STATe	8-24
SOURce:POWer:STATe?	8-25
SOURce:POWer:WAVElength	8-25
SOURce:POWer:WAVElength?	8-26
SYSTem Commands	8-26
SYSTem:DATE	8-27
SYSTem:DATE?	8-27
SYSTem:ERRor?	8-27
SYSTem:TIME	8-28
SYSTem:TIME?	8-29

9. HP-IB Application Commands

Program Commands	9-1
PROGram[:SELEcted]:EXECute	9-2
PROGram[:SELEcted]:NAME	9-2
PROGram[:SELEcted]:NAME?	9-3
PROGram[:SELEcted]:NUMBER	9-3
PROGram[:SELEcted]:NUMBER?	9-3
PROGram[:SELEcted]:STATe	9-4
PROGram[:SELEcted]:STATe?	9-4
Mainframe Applications	9-5
The Logging Application	9-5

The Stability Application	9-6
10. HP-IB Programming Examples	
Example 1	10-2
Example 2	10-3
Example 3	10-5
Example 4	10-7
Example 5	10-10
Example 6	10-13
Example 7	10-15
A. Installation	
Safety Considerations	A-1
Initial Inspection	A-2
Line Power Requirements	A-2
Line Power Cable	A-2
Operating Environment	A-4
Temperature	A-5
Humidity	A-5
Instrument Cooling	A-5
Input/Output Signals	A-5
HP-IB Interface	A-5
Cables and Adapters	A-6
Connector	A-6
HP-IB Logic Levels	A-7
Removing and Fitting Modules	A-7
How to Remove a Module	A-7
How to Fit a Module	A-8
Storage and Shipment	A-9
Claims and Repackaging	A-10
Return Shipments to HP	A-10
B. Accessories	
Mainframe	B-1
Modules	B-2
Connector Interfaces and Other Accessories	B-3

C. Specifications	
Mainframe Specifications	C-1
Declaration of Conformity	C-3
Acoustic Noise Emission	C-4
D. Function Tests	
Introduction	D-1
Equipment Required	D-1
Test Record	D-2
Test Failure	D-2
Instruments Specifications	D-2
IA. Function Test Using the HP 81533A	D-3
Display Function and Module Interface Tests	D-3
Display Function Tests	D-3
Module Interface Tests	D-4
ANALOG INPUT (8152A IN)	D-6
P.CTRL	D-6
IB. Function Test using a HP 81530/31/32 or HP 81536A	D-6
HP-IB Interface Test (Optional)	D-7
E. Cleaning Procedures	
Cleaning Materials	E-1
Cleaning Fiber/Front-Panel Connectors	E-2
Cleaning Connector Interfaces	E-2
Cleaning Connector Bushings	E-3
Cleaning Detector Windows	E-3
Cleaning Lens Adapters	E-3
Cleaning Detector Lens Interfaces	E-4
F. Local Control Summary	
Measure Mode	F-1
Menu Mode	F-2
System Mode	F-3
G. HP 8153A HP-IB Command Summary	
The Logging Application	G-4
The Stability Application	G-5

H. HP 8152A HP-IB Command Summary	
Differences	H-1
Using the FETCh Command - An Example	H-3
Setting the Filter	H-4
Listener Function	H-5
Settings	H-5
Standard Parameter Set	H-7
Talker Function	H-8
Interrogating Settings	H-8
Status/Error Reporting	H-10
Universal Commands	H-10
I. Error Codes	
Local Operation Error Codes	I-1
Module Related Errors	I-1
Specific Error Identifiers	I-2
Store and Recall Errors	I-2
Plot, Print, Show, and Manual Logging Errors	I-2
Loss Errors	I-2
HP-IB Errors	I-3
HP-IB Error Codes	I-3
No Error	I-3
Instrument Specific Errors	I-3
Command Errors	I-4
Execution Errors	I-6
Device Dependant Errors	I-7
Query Errors	I-8
J. Sales and Service Offices	
K. Backdating	
Instruments with Serial Numbers 2946G00475 and Earlier	K-1
Instruments with Serial Numbers 2946G00225 and Earlier	K-2
The Print Application	K-2
SAMPLES	K-2
COMMENT	K-2

Index

Figures

0-1. Line Power Cables - Plug Identification	v
1-1. The HP 8153A System	1-1
1-2. The HP 8153A Keyboard	1-2
1-3. The HP 8153A Display	1-6
1-4. Hardware Set Up for the Sample Session	1-8
1-5. The Display at the Start of the Sample Session	1-9
1-6. Editing the Sensor Wavelength	1-10
1-7. Reading the Power Output by the Source	1-11
1-8. Going into Menu Mode	1-11
1-9. A Plotter Connected to the HP 8153A	1-13
2-1. Measurements with $T_{Average} \leq 1$ second	2-4
2-2. Editing the Averaging Time Parameter	2-4
2-3. The Display while Channel A is Being Zeroed	2-10
3-1. Measuring the Reference for the Loss Application	3-3
3-2. Measuring the Loss of a Device Under Test (DUT)	3-4
3-3. The Loss Result	3-5
3-4. Setup for a Record Application	3-6
3-5. Selecting an Application : Stability	3-7
3-6. Editing an Application Parameter : Samples	3-10
3-7. Stability Plot	3-17
3-8. Logging Printout	3-22
3-9. The Window and Refresh Modes	3-25
3-10. Setup for an Alignment Application	3-28
3-11. The Display during the Alignment Application	3-30
4-1. Making a Selection in System Mode : the Recall Function	4-2
4-2. Editing a Parameter in System Mode	4-4
4-3. Setting the Brightness of the Display	4-7
6-1. Common Status Registers	6-2
7-1. The Registers and Filters in a Node	7-1
7-2. The Operation Registers	7-8
7-3. The Questionable Registers	7-14
7-4. The Source Register	7-20

8-1. Measurements with $T_{Average} \leq 1$ second	8-5
8-2. Measurements with $T_{Average} > 1$ second, continuous triggering.	8-5
8-3. Measurements with $T_{Average} > 1$ second, immediate triggering.	8-6
A-1. Line Power Cables - Plug Identification	A-4
A-2. HP-IB Connector	A-6
A-3. How to Remove a Module	A-8
A-4. Fitting a Module	A-9

Tables

1-1. Description of the Display	1-6
2-1.	2-6
2-2. Power Ranges	2-12
5-1. HP-IB Capabilities	5-2
5-2. Accepted Characters	5-4
5-3. HP-IB Bus Commands	5-5
6-1. Common Command Summary	6-4
6-2. The Standard Event Status Enable Register	6-5
6-3. The Standard Event Status Register	6-7
6-4. Reset State (Standard Setting)	6-11
6-5. The Service Request Enable Register	6-12
6-6. The Status Byte Register	6-13
7-1. STATus Command Summary	7-9
7-2. STATus Command Summary	7-15
7-3. STATus Command Summary	7-21
8-1. ABORt Command Summary	8-1
8-2. DISPlay Command Summary	8-2
8-3. FETCh Command Summary	8-4
8-4. INITiate Command Summary	8-7
8-5. READ Command Summary	8-8
8-6. SENSE Command Summary	8-10
8-7.	8-15
8-8. SOURce Command Summary	8-22
8-9. SYSTem Command Summary	8-26
9-1. PROGram Command Summary	9-2
G-1. STATus Command Summary	G-8
G-2. STATus Command Summary	G-9

1

2

3

Getting Started

This chapter introduces the features of the HP 8153A and gives you an opportunity to familiarize yourself with the way you operate the instrument.

The HP 8153A System

The central element of the system is the HP 8153A mainframe. You customize the instrument using plug-in modules and a changeable fiber-connector interfaces.

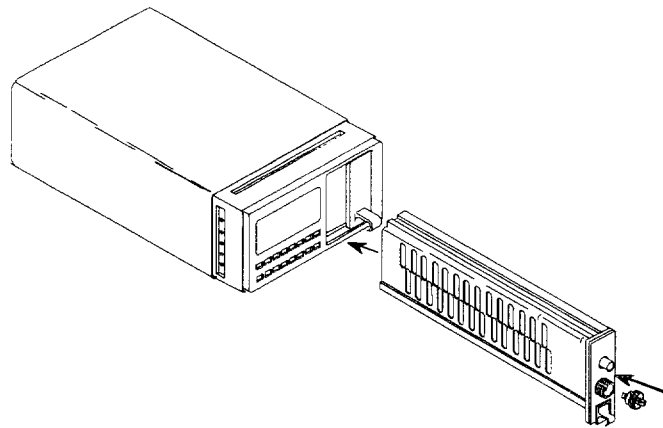

Figure 1-1. The HP 8153A System

A Quick Overview

The Keyboard

Most of the keys have two functions, depending on the selected mode. Different colors, or whether the legend is on the key or above it, show these different functions.

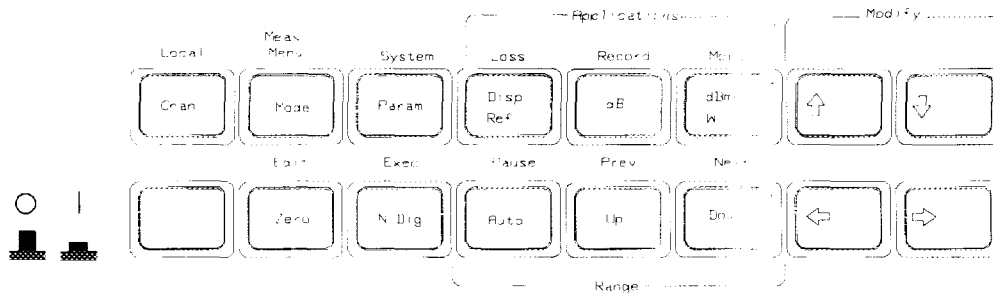

Figure 1-2. The HP 8153A Keyboard

The **Chan** key, the **Mode** key, and the modify keys always have the same function.

- Chan** Select the channel. The other keys act only on the selected channel. Channel A corresponds to the module in the left slot. Channel B corresponds to the module in the right slot.
- Mode** Switch between Measure and Menu Mode.
- Modify **←**, **→** Select the digit or character to edit.
- Keys **↕**, **↕** Edit the selected digit or character, or the parameter.

Measure Mode

Measure mode is the mode selected automatically when you switch on the instrument. In this mode you can set up and make simple measurements. In measure mode, the black writing on the key shows its function.

- Param** Select the measurement-parameter that you want to view or edit.

1-2 Getting Started

Disp→Ref	Measure and record the input power-level for use as a reference.
dB	Display the input power-level relative to a reference.
dBm/W	Switch between dBm and Watt units.
Zero	Measure the electrical noise in the instrument, and compensate for it.
N Dig	Select the number of decimal places shown in the result.
Range Keys	
Auto	Start or stop automatic ranging.
Up	Select the next higher measuring range.
Down	Select the next lower measuring range.

Menu Mode

In this mode there are pre-programmed routines to perform some common, but more complicated, measurements. In menu mode, the blue writing above the key shows the function of the key.

There are some keys whose operation is common to all of the tasks you do in menu mode.

- **Edit** gives you access to the parameters for editing.
 - **Prev** and **Next** step through the items in a menu. For example, these can be different types of Record applications, or the different parameters for the system configuration.
 - **Exec** to execute an application, or to finish editing a change of a system parameter.
 - **Pause** to pause the running application or to continue a paused application.
- System** Select system-parameters. This allows you to view or edit the configuration of the instrument.
- Loss** Select the Loss application. A loss measurement tells you how much of your optical signal you lose by passing it through a device. Loss is calculated by the following formula:

$$Loss = 10\log\left(\frac{P_{out}}{P_{in}}\right)dB$$

To measure loss you need both quantities, P_{in} and P_{out} . The application records P_{in} when you start the application. The instrument expresses all the following results relative to this. These results are loss results.

Record

Select from the Stability, Logging, Manual Logging, Plot or Print applications.

- Stability takes samples at evenly spaced intervals for a specified period.

The parameters for this application are

T_TOTAL Which sets the total time over which the measurements are to be made.

AUTODUMP Which sets whether the results are output to a printer or plotter when the application finishes.

- Logging takes a specified number of samples one immediately after the other. That is, as soon as the first sample has ended, the second starts.

The parameters for this application are

SAMPLES Which sets the number of samples to be taken.

AUTODUMP Which sets whether the results are output to a printer or plotter when the application finishes.

START Which sets whether the application starts immediately, or only after the power goes above, or below, a specified threshold level.

THRESHLD Which sets the threshold level to be passed before the application begins.

- Manual Logging takes a sample each time the user presses the **Exec** key.

In addition, the plot and print applications allow you to make a graphics plot, or a printout from the samples of your record application.

The parameters for the plot and print applications are

AUTOSCAL Which sets whether the axes are scaled automatically or not.

Y_MIN Which sets the minimum value for the y-axis.

Y_MAX Which sets the maximum value for the y-axis.

COMMENT Which allows you to add your own text to the printout or plot.

More

Select from the other applications. As standard, the instrument has Show and Alignment applications.

- The Show application lets you look at the sample values from the most recent Stability, Logging, or Manual Logging application. Some simple statistics for the results are also given.
- The Alignment application gives you visual, and audible feedback of the input power, to help you align two components for the maximum transfer of optical power.

The parameters for this application are

TYPE	Which sets whether the maximum transferred power is determined automatically by the instrument, or set manually by the user.
DELTA	Which sets the size of the change in transferred power indicated on the display, or by the tone.
MAXPOWER	Which sets expected, or required, maximum transferred power.

The **Pause** key switches on and off the tone.

The Display

The display shows the status and the readings.

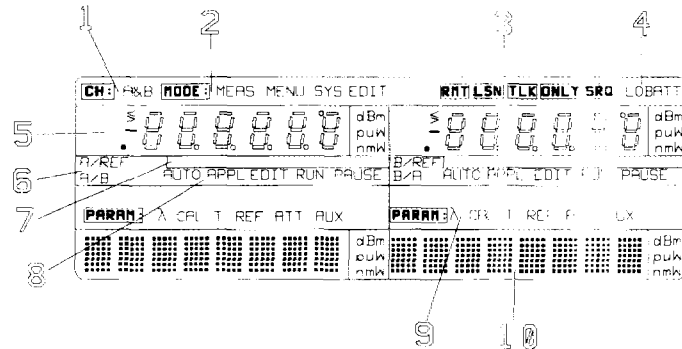

Figure 1-3. The HP 8153A Display

Table 1-1. Description of the Display
Description

1 Channel Indicator	Shows the selected channel.
2 Mode Indicator	Shows the operating mode.
3 Communications Indicator	Shows the state of the HP-IB communications.
RMT	Remote communications are taking place.
TLK ONLY	Talk-only selected for the HP-IB.
SRQ	A service request is pending.
4 Low Battery Indicator	Indicates that the internal battery voltage is low.

Table 1-1. Description of the Display (continued)

	Description
5 Result Field	This is where the results of tests or applications are shown.
6 Reference Indicator A/REF or B/REF A/B or B/A	Shows the reference used for a dB result. Results relative to a reference. Results relative to the other channel.
7 Bar Graph	Gives a linear graphical representation of the result.
8 Operation Indicator AUTO APPL EDIT RUN PAUSE	Shows the operation type. The range is being selected automatically. An application has been selected. An application parameter is being edited. An application is running. An application has been temporarily halted.
9 Parameter Indicator λ CAL T REF ATT AUX	shows the type of parameter in the character field. Character field shows wavelength. Character field shows the calibration factor. Character field shows the averaging time. Character field shows the reference level. Character field shows the attenuation of the source. Auxiliary Parameters.
10 Character Field	Used for parameters, and error messages.

A Sample Session

In this sample session you recall the standard setting, take a power measurement, and then do some data logging.

Hardware Setup

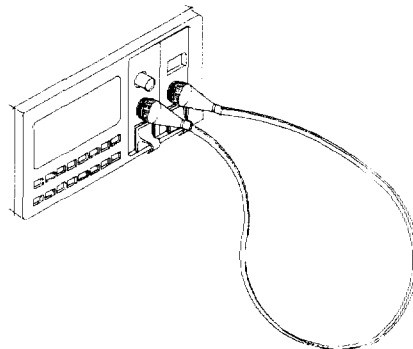

Figure 1-4. Hardware Set Up for the Sample Session

This session assumes that you have a multimeter configured with one source and one sensor module. The source module is in channel B and the sensor module is in channel A. Attach the source to the sensor with a piece of optic fiber. At the start of the session, make sure that the instrument is off.

Switching On and Recalling the Standard Setting

1. Set up the instrument as described above.
2. Switch on the instrument. All the display lights, and then the message SELFTEST shows in the character field in both channels. The following are the default power on conditions.
 - The current channel is channel A.
 - The instrument is in measure mode.
 - The source is inactive.
 - The sensor is reading the optical power at its input. Autoranging is enabled.

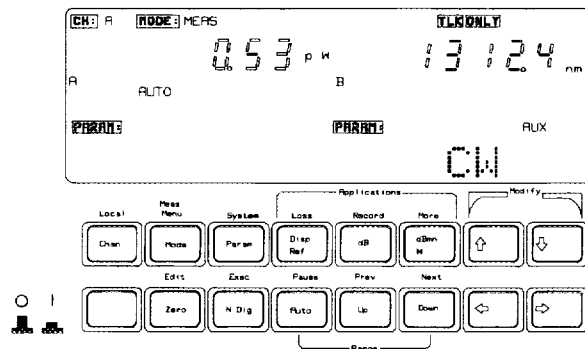

Figure 1-5. The Display at the Start of the Sample Session

3. Press **(Mode)**. The instrument goes to menu mode. It shows the **MENU** mode indicator at the top of the display and the word **MENU** in the character field at the bottom of the display.
4. Press **(System)**. The instrument goes into system mode, it shows the **MENU SYS** mode indicator. The character field shows the message **RECALL**. The rest of the display is off.
5. Press **(Edit)**. The instrument shows the **MENU SYS EDIT** mode indicator and the message **RECALL 0→A** shows in the character field.
6. Press **(Exec)** to recall the standard setting for channel A. The **RUN** operation indicator shows while the setting is being recalled.
7. Press **(↑)**. The instrument shows the message **RECALL 0→B** in the character field.
8. Press **(Exec)** to recall the standard setting for channel B.
9. Press **(Mode)** to return the instrument to measure mode.

Making A Power Measurement

Note



Normally, the instrument is left for 20 minutes to warm up. Maximum accuracy is only possible if the instrument is allowed to warm up. For this sample session we do not need this accuracy, so you can go to the next step immediately.

10. Press **Param** until the λ parameter indicator for channel A lights. The character field on the left hand side now shows the wavelength for the sensor. The wavelength of the source shows in the result field on the right side. Set the wavelength of the sensor to the wavelength of the source.

Use **←** and **→** to select a modifiable digit. The modifiable digit blinks. Use **↑** and **↓** to alter the value of this digit.

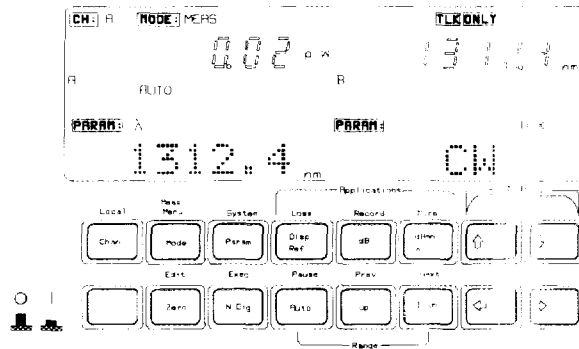

Figure 1-6. Editing the Sensor Wavelength

11. Press **Zero** to remove any electrical offsets in the circuitry. The message ZEROING is shown in the character field and ---- shows blinking in the result field.
12. Enable the source by pressing the button on its front panel. The green LED lights to show that the source is now active.
13. The instrument shows the power of the source in the result field of channel A, in Watts.

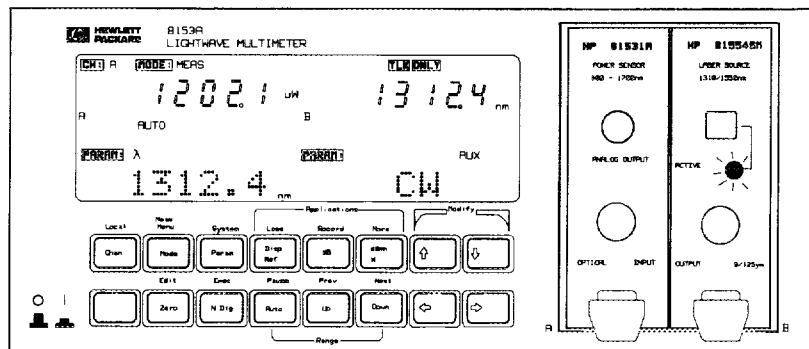

Figure 1-7. Reading the Power Output by the Source

Logging Data

You will now set up the instrument to record 250 consecutive power readings. The instrument starts this part with the settings used after the section “Making a Power Measurement”.

14. Press **Menu** to change to menu mode. The mode indicator changes to show MENU. MENU is displayed in the character field.

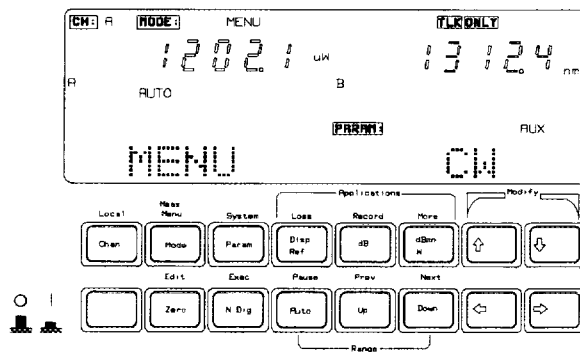

Figure 1-8. Going into Menu Mode

15. Press **Record** to choose a record application. The APPL operation indicator switches on. The character field shows STABILTY. Press **Record** again, so that the character field shows LOGGING.

16. Press **Edit**, the EDIT operation indicator lights and the character field on the left shows SAMPLES. The other character field shows the setting for the number of samples to be taken.

Use the Modify keys to set the number of samples to 250.

17. Press **Next**, the character field shows AUTODUMP. Make sure that it is OFF. If it is not, use **↑** or **↓** to switch it OFF.
18. Press **Next**. The character field shows START Use **↑** or **↓** to set the state to IMMEDIAT. This means that the logging starts immediately when you execute it.
19. Press **Edit** again to get back to the display with LOGGING in the character field.

You have now set the parameters for the application. The application takes a just under a minute to record the values. While it is running try moving and twisting the fiber to change the power received at the sensor.

20. Press **Exec** to start the application. The instrument shows the RUN operation indicator. While the application is running, the character field shows the number of the sample that is being taken. When the application finishes, the RUN indicator goes out.

Examining the Data

After you have run the Logging application, you can look at the data that has been recorded. You do this using the Show application.

21. Press **More**. The character field shows the word SHOW.
22. Press **Edit**. The character field now shows MAXIMUM and the value of the highest reading taken during the logging.
23. Press **Next**. The character field now shows MINIMUM and the value of the lowest reading taken during the logging.
24. Press **Next**. The character field shows DIFF and the difference between the highest and lowest readings.
25. Press **Next**. The character field shows AVERAGE and the average of the readings.
26. Press **Next**. The character field shows # 1 and the value of the first reading. To examine all the readings, use the **↑** and **↓**.

27. When you have finished examining the readings, press **Edit** to get back to the display with SHOW in the character field.

Plotting Data

Now that you have recorded the data, you can plot it on a plotter using the Hewlett-Packard—Interface Bus (HP-IB).

28. Attach the instrument to a graphics-plotter that has HP-GL capabilities. Attach the plotter to the HP-IB connector. Do not attach any other device to this connector at the same time as the plotter. Make sure that the plotter is configured at address 5.
29. Make sure that the instrument is in Talk Only mode. When the instrument is in Talk Only mode, the **TLK ONLY** shows at the top of the display. If the instrument is not in Talk Only mode use the following procedure to put it into Talk Only mode
 - a. Press **System** repeatedly until HPIB shows in the character field.
 - b. Press **Edit**. The character field shows the message ADDRESS and the HP-IB address of the HP 8153A.
 - c. Press **Next**. The character field shows the message MODE. The word TLK LSTN is blinking.
 - d. Use the modify keys to set the HP-IB state to TLK ONLY.
 - e. Press **Edit** to return to the display with HPIB in the character field.

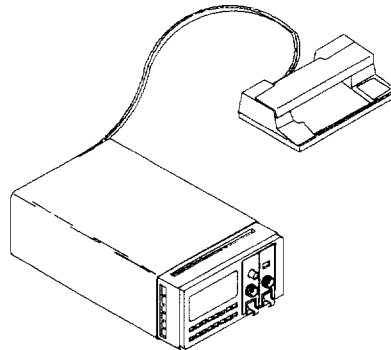

Figure 1-9. A Plotter Connected to the HP 8153A

30. Press **Record** repeatedly, until the message PLOT shows in the character field.
31. Press **Edit**. The character field shows AUTOSCAL. Use the modify keys to set this parameter to ON. This means that the instrument automatically scales the plot.
32. Press **Next**. The character field shows COMMENT. The comment is a message that prints on the plot. Use the modify keys to enter a comment. Use **←** and **→** to select a character position in your comment. Use **↑** to select a letter and **↓** to select a number for your comment.
33. Press **Edit** to get back to the display with PLOT in the character field.
34. Press **Exec** to plot the readings.

The RUN Mode indicator shows while the graph of the results plots. When the plot has finished the RUN indicator switches off.

This ends the sample session.

Measure Mode

The default mode at switch-on is Measure Mode. When the instrument is in measure mode, the mode-indicator shows MEAS. In measure mode, the function of key is shown by the black legend on the key.

The Chan Key

Chan selects the channel. This can be A or B. The channel- indicator, at the top of the display, shows the selected channel.

Note Functions in Measure mode apply only to the selected channel.



When the instrument is under remote operation, this key acts as **Local**. That is, it returns the instrument to local operation (unless Local Lockout is active).

The Mode Key

Mode changes the operating mode. If you press this key in measure mode, it changes the instrument into menu mode (the next chapter gives a description of menu mode).

Note The commands described in this chapter can only be used when the instrument is in Measure mode.



The Param Key

Use **Param** to select a measurement-parameters for editing. The parameter-indicator shows the selected parameter, the character field shows the value of the parameter. You can select the next parameter by pressing **Param** again. When the hardware does not use a particular parameter, you cannot select it.

When you have selected a parameter, you can edit it using the Modify keys (described later in this chapter). Some parameters are set by the instrument, these cannot be edited.

The Applications in Menu mode also use the parameters set in Measure mode.

Entry Status

When you select a parameter, the editable part blinks. The editable part can be one digit or character, or the whole parameter. You can only edit a parameter, or a part of a parameter, while it is blinking.

If you do not press any more keys within 10 seconds, the blinking stops and you are prevented from editing the value. You can enable editing again if you press any of the Modify keys.

Note



The instrument holds the parameter information in memory until you edit it. Switching the instrument off does not affect the parameters.

Default Values

If you hold down **Param** for 2 seconds or longer, the parameter is set to its default value.

Parameter List

The parameters and their specifications are as follows:

λ

This is the wavelength value. Sometimes, you can set the wavelength to any value within limits set by the module (for example, for a power sensor). For other modules, you can choose one wavelength from two possibilities (for

example, multi-wavelength sources). In other cases, the module sets this value and you can display the value but you cannot edit it.

Display Format	<i>nnnn.n</i> nm
Limits	Depends on the module used.
Resolution	0.1nm
Default	Depends on the module used.

CAL

This is a calibration offset that you can enter to compensate for external optical circuitry. This value is automatically subtracted from the input signal.

$$P_{measured}(dBm) = P_{input}(dBm) - CAL(dB)$$

Where,

$P_{measured}$ is the adjusted value of the signal read,
 P_{input} is the input signal level, and
 CAL is the calibration offset.

Display Format	$\pm nnn.nnn$ dB
Limits	$-200.000dB \leq nnn.nnn \leq +200.000dB$
Resolution	.001dB
Default	0.000dB

When the calibration factor is not set to zero, the CAL parameter- indicator stays on at half brightness.

T

This is the length of time over which a signal is averaged. Longer averaging times increase the accuracy and improve the noise rejection of the measurement. Longer averaging times also decrease sensitivity and increase the length of time between updates of the results on the display.

For averaging times of 1 second or less, a new measurement is shown on the display at the end of each averaging time. This is drawn in Figure 2-1. A new measurement is shown on the display at each x.

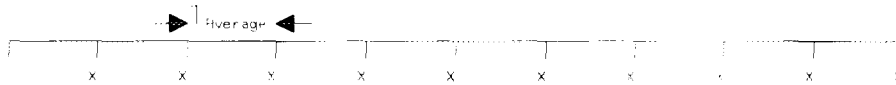

Figure 2-1. Measurements with $T_{Average} \leq 1$ second

For averaging times of more than 1 second, the x value is given by the formula

$$x_{new} = x_{old} \left(1 - \frac{T_{sample}}{T_{avg}} \right) + Sample \left(\frac{T_{sample}}{T_{avg}} \right)$$

Where

- x_{new} is the new, displayed result,
- x_{old} is the previously displayed result,
- Sample is the value read by the hardware,
- T_{avg} is the averaging time (as set by the user), and
- T_{sample} is the time taken, by the hardware, to make a reading.

If the measurement conditions are changed (for example, by a range change in autoranging) x_{old} is reset, and the averaging starts again. This is why the display update seems faster in autoranging.

Display Format *nnn ms, s, min*

Values 20, 50, 100, 200, 500ms, 1, 2, 5, 10, 20, 30s, 1, 2, 5, 10, 15, 20, 30, 60min

Default 200ms

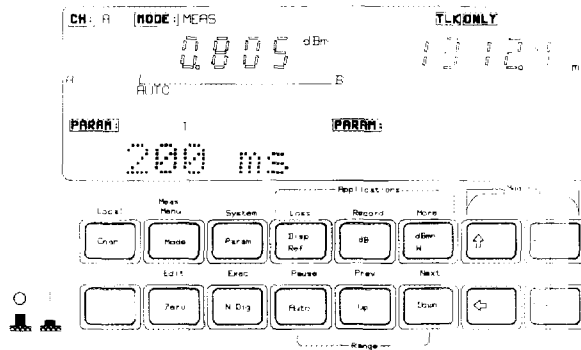

Figure 2-2. Editing the Averaging Time Parameter

2-4 Local Control - Measure Mode

REF

dB results are shown relative to a reference-level. This parameter sets the reference-level. You can choose the units for the reference using **(dBm W)**.

Setting, or changing, the reference only affects results that are displayed in dB.

$$P_{display}(dB) = P_{measured} - REF$$

Where,

$P_{display}$ is the displayed, relative power,
 $P_{measured}$ is the absolute power-level (see "CAL"), and
 REF is the reference.

Logarithmic Units

Display Format $\pm nnn.nnn$ dBm

Limits $-200.000\text{dBm} \leq nnn.nnn \leq +200.000\text{dBm}$

Resolution 0.001dBm

Default 0.000dBm

Linear Units

Display Format 5 digits pW, nW, μ W, mW.

Limits $0.001\text{pW} \leq n \leq 9999.9\text{mW}$

Resolution see Table 2-1

Default $1000.0\mu\text{W}$

Table 2-1.

Range	Upper Limit Linear Power	Resolution @T≥100ms
+30dBm	1999.9mW	100μW
+20dBm	199.99mW	10μW
+10dBm	19.999mW	1μW
0dBm	1999.9μW	100nW
-10dBm	199.99μW	10nW
-20dBm	19.999μW	1nW
-30dBm	1999.9nW	100pW
-40dBm	199.99nW	10pW
-50dBm	19.999nW	1pW
-60dBm	1999.9pW	0.1pW
-70dBm	199.99pW	0.01pW
-80dBm	19.999pW	0.001pW

ATT

The amount of power that is output from a source can be controlled. This parameter sets the attenuation of an output.

$$P_{output} = P_{source} - ATT(dB)$$

Where,

P_{output} is the power-level at the output of the module,

P_{source} is the power-level at the output of the source, and

ATT is the attenuation parameter.

Display Format $\pm n.n$ dB

Limits $0.0dB \leq n.n \leq 6.0dB$

Resolution 0.1dB

Default 0.0dB

2-6 Local Control - Measure Mode

AUX

The output amplitude of a source can be modulated by a square wave. This parameter sets the frequency of the modulation. The modulation can be one of CW (continuous wave, that is no modulation), 270Hz, 1kHz, or 2kHz.

Values CW, 270Hz, 1, 2kHz
 Default CW

The Disp→Ref Key

Pressing this key takes the input power-level and stores it as the reference. Setting, or changing, the reference in this way only affects results displayed in dB.

If the display is in dBm or Watts, the measured power-level is stored as the reference, that is

$$REF = P_{measured}$$

Where,
 REF is the reference, and
 $P_{measured}$ is the absolute power-level (see "CAL").

If the display is in dB, this value is converted to dBm or Watts before being stored as a reference, that is

$$REF_{new} = P_{display}(dB) + REF_{old}$$

Where,
 REF_{new} is the reference after the key press,
 $P_{display}$ is the displayed, relative power, and
 REF_{old} is the reference before the key press.

The dB Key

This key switches the display to show results in dB. Results in dB are always given with respect to another power-level. This can be a stored reference, or it can be a second power-level.

Using **[dB]** with a Two Sensor Instrument

For an instrument with two sensors, the dB result can be with respect to the reference stored for the channel, or it can be with respect to the power-level of the other channel.

If the result is in dB with respect to the power-level of the other channel, **[dB]** changes the result to dB with respect to the stored reference. The reference-indicator shows A/REF or B/REF. To see the reference, use **[Param]**. To set the reference you use **[Param]** or **[Disp→Ref]**.

$$P_{display}(dB) = P_{measured} - REF$$

Where,

$P_{display}$ is the displayed, relative power,
 $P_{measured}$ is the absolute power-level (see "CAL"), and
 REF is the reference.

If the result is in dB with respect to the reference, **[dB]** changes the result to dB with respect to the power-level in the other channel. The reference-indicator shows A/B or B/A. When the result is with respect to the power-level in the other channel, the stored reference is also used in the calculation of the displayed result.

$$P_{display}(dB) = P_{measured_{1st\ Channel}} - P_{measured_{2nd\ Channel}} - REF$$

Where,

$P_{display}$ is the displayed, relative power,
 $P_{measured}$ is the absolute power-level (see "CAL"), and
 REF is the reference.

If the result is in dBm or Watts, **[dB]** changes the result to dB.

Using **[dB]** with a One Sensor Instrument

[dB] changes the display to show the result as a relative value with respect to the stored reference. The reference-indicator shows A/REF or B/REF. To see the reference, use **[Param]**. To set the reference, use **[Param]** or **[Disp→Ref]**.

$$P_{display}(dB) = P_{measured} - REF$$

Where,

$P_{display}$ is the displayed, relative power,
 $P_{measured}$ is the absolute power-level (see "CAL"), and
 REF is the reference.

The dBm/W Key

This key changes the display to show results in dBm or in Watts.

If the results are in dB, **[dBm W]** changes the display to showing the result as dBm or Watts.

If the results are in dBm, **[dBm W]** changes the display to showing the results in Watts.

If the results are in Watts, **[dBm W]** changes the display to showing the result in dBm.

The Zero Key

The **[Zero]** works with sensor modules. The function of **[Zero]** is to remove any electrical offset in the sensor circuitry.

The instrument measures by converting optical power to electrical power, and then measuring the electrical power. An electrical offset is power that is always present, even if there is no light at the input. If this offset is not removed, it will affect the results.

[Zero] measures the electrical power when there is no light at the input. The instrument uses this value to remove the offset from all further incoming signals.

Note

The environmental conditions and the temperature of the instrument affect the electrical offset. For the best results you must:

- Allow the instrument time to acclimatize (c.24 hours).
- Allow the instrument time to warm up (c.20 minutes).
- Make sure that the optical input is not receiving any light. If you are using multi-mode cable you must disconnect the cable and cover the input to the sensor to perform a zero.

It is a good practice to zero the instrument before making any important measurements.

The zero operation is performed just for the selected channel. The instrument automatically repeats the zero operation for each measurement range.

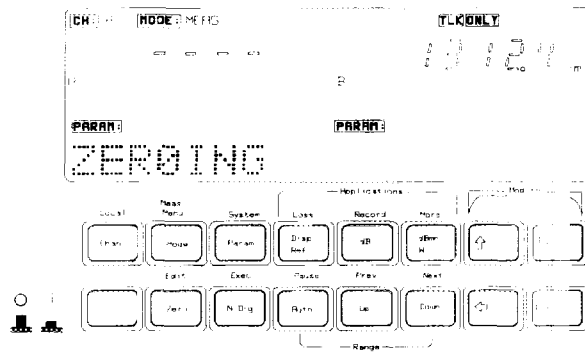

Figure 2-3. The Display while Channel A is Being Zeroed

If there is light at the sensor input during a zero operation, the instrument shows the message ZERO ERR. If you cannot remove the light, but you still want to use the instrument, you can abort the zero operation by pressing any key.

The N Dig Key

This key selects the number of digits shown after the decimal point in the result. When you use **(N Dig)** first, it reduces the number of digits shown. After the number of digits has been reduced to 1, **(N Dig)** increases the number of digits shown. The maximum number of digits after the decimal point is 3.

The Range Keys

The range keys select the range of the units for the result. The table below gives the possible ranges for results. The available ranges depend on the module used.

Table 2-2. Power Ranges

Range	Upper Linear Power Limit
+30dBm	1999.9mW
+20dBm	199.99mW
+10dBm	19.999mW
0dBm	1999.9 μ W
-10dBm	199.99 μ W
-20dBm	19.999 μ W
-30dBm	1999.9nW
-40dBm	199.99nW
-50dBm	19.999nW
-60dBm	1999.9pW
-70dBm	199.99pW
-80dBm	19.999pW
-90dBm	1.999pW
-100dBm	0.199pW
-110dBm	0.019pW

The range the instrument is using shows on the display while you press a range key. But, note that pressing a Range key alters the range used. Pressing **Auto** stops or starts the automatic ranging. Pressing **Up** or **Down** selects the next range before showing it.

The bar graph below the result shows the result graphically. The left end of the bar is 0% of the selected range, the right end of the bar is 100% of the selected range.

The Auto Key

Auto enables or disables automatic ranging for the result. Automatic ranging ensures that the result has a displayed value between 9% and 100% of full scale. While you have automatic ranging enabled, the operation-indicator shows AUTO in the middle of the display. The default state is for automatic ranging to be enabled.

The Up Key

This key selects the next higher range. If automatic ranging was in operation, this key disables it.

Example If the instrument is currently in the range 2.000 to 19.999 μ W, pressing **Up** takes it to the 20.00 to 199.99 μ W range.

The Down Key

This key selects the next lower range. If automatic ranging was in operation, this key disables it.

Example If the instrument is currently in the -20dBm range, pressing **Down** takes it to the -30dBm range.

The Analog Output

The analog output is the BNC connector on the front of the sensor module. It outputs a voltage directly proportional to the strength of the optical signal at the optical input, in the current range.

The analog signal is always in the range 0 to 2V, 2V corresponding to a full power input signal **in the current range**, 0V corresponding to no input signal. If the range changes, for example, during autoranging, the level to which 2V corresponds changes. Therefore it is recommended, if you want to use the analog output, disable autoranging and select the best range for the application with **Up** or **Down**.

Possible applications for the analog output, would be to close the feedback loop controlling the current supplied to a laser; or to monitor optical power on an oscilloscope (the analog signal reacts instantaneously to the input signal, whereas the power shown on the display is subject to averaging).

The Modify Keys

You use these keys to edit parameters. For the purposes of editing, there are two types of parameter. One type is the parameter that can have one of several, separate values, these are discrete valued parameters. The second type is the parameter that can have any value between certain limits, these are continuous valued parameters.

Editing Discrete Valued Parameters

When selecting one of several discrete values, the \uparrow selects the next highest value and the \downarrow selects the next lowest value.

Example The averaging time can have only particular values. If you are editing this parameter and it is currently 200ms, pressing \uparrow changes the value to 500ms. If you are editing this parameter and it is currently 200ms, pressing \downarrow changes the value to 100ms.

\Rightarrow and \Leftarrow have no effect in the editing of discrete valued parameters.

Editing Continuous Valued Parameters

Where a value is being set from between certain limits, you can edit each character individually.

The \Leftarrow changes the editable character to the next one on the left. The \Rightarrow changes the editable character to the next one on the right. The editable characters include each digit of numeric parameters, the decimal point (see below), and characters in messages. When a character is selected for editing it blinks.

Pressing \downarrow decrements the editable character. The \uparrow increments the editable character.

Editing Units

To edit the magnitude of Watt values, select the decimal point as the editable character. Use the \downarrow to move the decimal point to the left, use \uparrow to move the decimal point to the right.

When the decimal point reaches its rightmost or leftmost position, pressing the key again changes the multiplier of the units.

Example

If you are editing a reference, and the value is $234.5\mu\text{W}$, with the field of edit at the decimal point, pressing \downarrow changes the value to 2.345nW .

Similarly, if you are editing a reference, and the value is $2.345\mu\text{W}$, with the field of edit at the decimal point, pressing \uparrow changes the value to 234.5mW .



Menu Mode

In menu mode the instrument offers several advanced test applications. When the instrument is in this mode, the mode-indicator shows MENU. In this mode the blue legends, above the keys, show the commands available to the user.

The Chan Key

Chan selects the channel. This can be A or B. The channel- indicator, at the top of the display, shows the selected channel.

Note Functions in the Menu mode apply only to the selected channel.



When the instrument is under remote control, this key acts as **Local**. That is, it returns the instrument to local control (unless Local Lockout is active).

The Mode Key

Mode changes the operating mode. If you press this key in menu mode, it changes the instrument into measure mode (the previous chapter gives a description of measure mode).

Note The commands described in this chapter can only be used when the instrument is in Menu mode.



The System Key

System changes the instrument to system mode (the next chapter gives a description of system mode).

3

The Modify Keys

The section "The Modify Keys" in Chapter 2, gives a description of how to use the Modify keys.

The Loss Key

Loss starts the loss application. You need both a source and a sensor module to run this application.

A loss measurement tells you how much of your optical signal you lose by passing it through a device. You calculate loss by the following formula:

$$Loss = 10 \log \left(\frac{P_{out}}{P_{in}} \right) dB$$

To measure loss you need both quantities, P_{in} and P_{out} . The application measures P_{in} when you start it running. Once you have taken a reference, the instrument expresses all the following results relative to this. These results are loss results.

Preparation

You need both a source and a sensor module for the Loss application.

Before you start the Loss application, make sure that you have set all the measurement-parameters that you use. It is most important to make sure that you have set T for the sensor and λ for the source. If you are already in Menu mode, you have to return to Measure mode to set these parameters.

Running the Loss Application

After pressing **Loss**, the instrument checks to see if both a source and sensor module are present. If one or both are missing the character field shows the message CONFIG ?. The instrument does not enter the loss application.

If both modules are present:

- The sensor wavelength is automatically set to the wavelength of the source. (When you stop the application running, the parameters for the sensor are automatically reset to the values in use before you started the application.)
- The operation-indicator shows APPL, this stays lit while the instrument is in the loss application.
- The instrument shows LOSS in the character field.

The instrument reads the reference level when you start the application running. To read the input signal and use it as the reference, do the following:

1. Make sure that the device under test is not in the system.
2. Make sure that the source is not active. The source *is* active whenever the green LED on its front panel lights.
3. Connect the source to the input of the system without the device under test.
4. Connect the output of the system to the sensor.

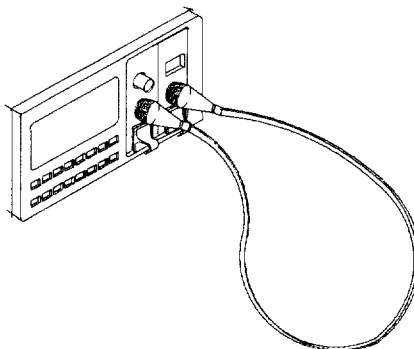

Figure 3-1. Measuring the Reference for the Loss Application

5. Press **Exec**.

The instrument takes the reference and then runs the application. While the application is running, the RUN operation-indicator lights.

Warning

Do not look into the end of an optical cable attached to a laser output when the device is operational.

Note

Do not disconnect the fiber from the source when making a loss measurement. A small change in the coupling at the source can introduce large errors into your measurement.

Once you have taken the reference, you can place the device under test into the system.

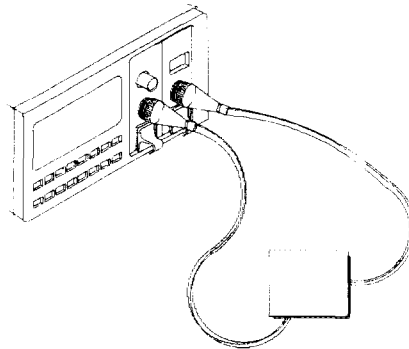

Figure 3-2. Measuring the Loss of a Device Under Test (DUT)

Do not stop and restart the application as you insert and change devices under test. Every time you start the application, the instrument takes a new reference. You can switch the source off and on without disturbing the reference value. Do this to avoid exposure to laser radiation when you are changing the device under test.

While the application is running, the result field shows the loss, in dB, and the character field shows the reference, in dBm. 1 indicates the result field and 2 indicates the character field in Figure 3-3. If you are using both wavelengths of a dual wavelength source, the loss and reference for both wavelengths are displayed. The loss and reference for the lower wavelength is shown on the left. The loss and reference for the higher wavelength is shown on the right.

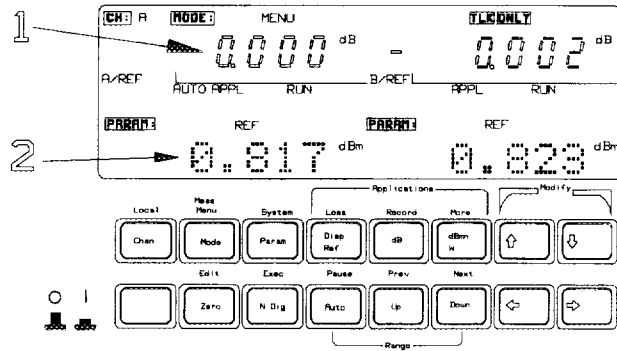

Figure 3-3. The Loss Result

Exec stops the application running.

The Record Key

Record starts the record applications. Record applications allow you to take a number of samples in succession. There are three types of record application.

- **Stability** takes samples at evenly spaced intervals over a specified period.
- **Logging** takes a specified number of samples one immediately after the other. That is, as soon as the first sample has ended, the second starts.
- **Manual Logging** takes a sample each time the user presses the **Exec** key.

In addition, there are plot and print applications that allow you to make a graphics plot, or a printout of the samples of your record application.

The final application on the Record key is the MinMax application, which displays minimum measured value and the difference between this minimum and the maximum measured value, for a changing power level.

Preparation

You need a sensor module to perform any of the record applications. For the stability, or either of the logging applications, the only hardware setup you need is to have the device under test connected to the sensor.

3

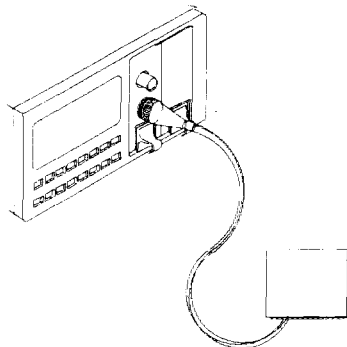

Figure 3-4. Setup for a Record Application

To make a plot of the samples you need a HPGL plotter. To get a printout of the samples you need a ThinkJet printer. If you are using a plotter or a printer, it must be attached as the only device to the HP-IB connector on the back of the instrument. The device address of the plotter must be set to 5. The device address of the printer must be set to 1. To output to a printer or plotter, the instrument HPIB State must be set to Talk Only (for instructions on how to do this see "MODE" in Chapter 4).

With Firmware revisions 1.7 and greater, to output to a printer or plotter, the instrument HPIB State must be set to Talk Listen.

Note



To find the firmware revision, switch off the instrument, and then hold any key while the instrument is powering up. The firmware revision is shown at the bottom right of the display.

Before you start a record application, make sure that you have set all the measurement-parameters that you use. It is most important to make sure that you have set T and λ for the sensor. If you are already in Menu mode, you have to return to Measure mode to set these parameters.

After pressing **Record**, you choose an application using **Record**, **Next** or **Prev**. **Record** and **Next** choose the next of the record applications. **Prev** chooses the previous of the record applications. While you are in the record applications the APPL operation-indicator lights. The application is displayed in the character field of the selected channel.

The Stability Application

In the Stability application the instrument makes a number of evenly spaced samples over a period specified by the user. The application first takes consecutive samples of the power from the device under test (that is, the next sample begins as soon as the previous one has finished). Some of this data is then discarded so that the samples are evenly spaced over the whole of the specified period. The maximum number of samples is 500.

Example T_{avg} is set to 1s (T_{avg} is T set in Measure mode). The user sets the total time for the stability application to 8 minutes and 22 seconds. This is a total time of 502 seconds. The instrument takes 502 samples, but discards every second sample so that at the end, there are 251 evenly spaced samples.

When you select the Stability application the character field shows STABILTY.

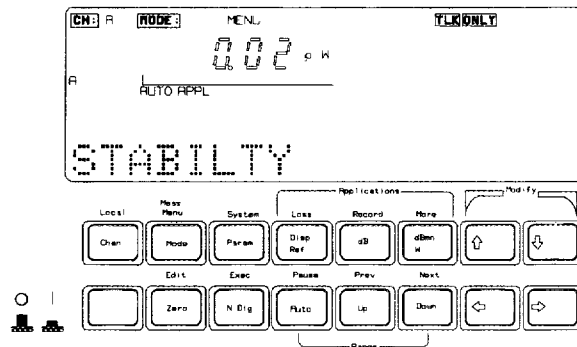

Figure 3-5. Selecting an Application : Stability

This application has two parameters. T_TOTAL sets the total time for Stability application. $AUTODUMP$ enables or disables the automatic plotting or printing

of the samples when the application finishes. All the other parameters (Wavelength, T_{avg} , etc.) use the values given to them in measure mode.

Press **Edit** to look at, or edit the parameters. After pressing **Edit**, you can select parameters using **Next** and **Prev**. While you are editing a parameter, the EDIT operation-indicator lights.

3

T_TOTAL

When you select this parameter, the left side character field shows the message T_TOTAL. The right side character field shows the value for the total time.

- You edit the time using the Modify keys. The lower limit for the time is 1 second. The higher limit for the total time is 99 hours, 59 minutes and 59 seconds. The displayed value is always the setting for the total time. Due to the way the measurements are taken, you may find that the application runs for a little longer than T_TOTAL. The difference of the actual total time from T_TOTAL depends on a number of factors including the system configuration. The worst case timing difference is 30s/h.
- You can press **Edit** if you have finished editing, or you can press **Next** or **Prev** to edit the other parameter.

AUTODUMP

When you select this parameter, the left side character field shows the message AUTODUMP. The right side character field shows whether the automatic dump has been enabled. The dump can be a plot of the samples or a printout of the samples. If the automatic dump is enabled the dump is made after the Stability application has taken the last sample.

Note



- Other applications also use the same AUTODUMP parameter. Changing this parameter in the Logging application affects the Stability application.
- The Plot application sets the parameters for an automatic plot. The Print application sets the parameters for an automatic print. These applications are described later in this chapter.
- You should not enable automatic dumping to a printer or plotter if there is a logging or stability application running in the other channel. The automatic dump is given priority, and the application in the other channel will be stopped for the duration of the print or plot.

In the case of a logging application, the linearity of the timing information is affected. In the case of a stability application, no new data is recorded while the dump is being made.

- You edit the dump enable using the Modify keys. It can have the value OFF, to disable both the automatic plot and the automatic print, PLOTTER to enable the plot, or PRINTER, to enable the print. The displayed value is always the setting for the dump.
- You can press **Edit** if you have finished editing, or you can press **Next** or **Prev** to edit the other parameter.

3

Running the Stability Application

To run the application, press **Exec**. You cannot run the application if you are editing parameters. While the application is running, the RUN operation-indicator lights.

While the application is running, the result field shows the sample, and the character field shows the time remaining until the application finishes. After all the samples have been taken, the RUN operation-indicator switches off.

Pause suspends the running of the application. You can restart it by pressing **Pause** a second time. When you have pressed pause, you can look at the parameters set for the application in the Measure mode. You select parameters with **Next** and **Prev**.

Exec stops the application running.

The Logging Application

In the Logging application the instrument makes a number of consecutive samples. The user specifies the number of samples. Consecutive samples are samples where one begins as soon as the previous one has finished.

When you select the Logging application the character field shows LOGGING. This application has several parameters. SAMPLES sets the number of samples that are to be taken. AUTODUMP enables or disables the automatic plotting or printing of the samples when the application finishes. START determines the conditions that have to be met before the application starts taking samples. THRESHLD sets the threshold power that must be crossed before the application

starts taking samples. All the other parameters (Wavelength, T_{avg} , etc.) use the values given to them in measure mode.

Press **Edit** to look at, or edit the parameters. After pressing **Edit**, you can select parameters using **Next** and **Prev**. While you are editing a parameter, the EDIT operation-indicator lights.

3

The total time for the logging application consists of the averaging time and the time to process the sample. That is, a sample is only taken after the previous sample has been taken and processed.

The processing time depends on a number of factors including the system configuration. If any applications or measurements are running in the other channel, the processing time between samples may vary.

On printer or plotter outputs, the total time given for the logging application includes both the averaging and the processing time.

SAMPLES

When you select this parameter, the left side character field shows the message SAMPLES. The right side character field shows the number of samples to be taken.

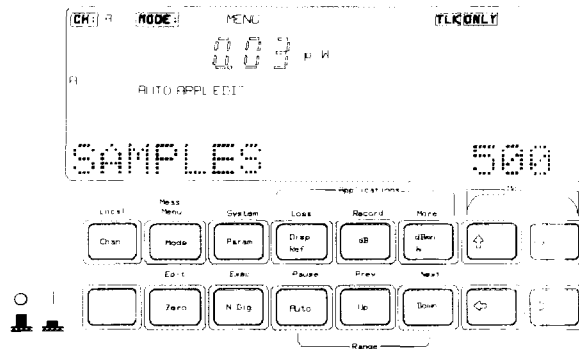

Figure 3-6. Editing an Application Parameter : Samples

- You edit the number of samples using the Modify keys. The lower limit is 2. The higher limit is 500. The displayed value is always the setting for the number of samples.

- You can press **Edit** if you have finished editing, or you can press **Next** or **Prev** to edit the other parameters.

AUTODUMP

When you select this parameter, the left side character field shows the message AUTODUMP. The right side character field shows whether the automatic dump has been enabled. The dump can be a graphic plot of the samples or a printout of the samples. If the automatic dump is enabled the dump is made after the Stability application has taken the last sample.

Note



- Other applications also use the AUTODUMP parameter. Changing this parameter in the Logging application affects the Stability application.
- The Plot application sets the parameters for an automatic plot. The Print application sets parameters for an automatic print. These applications are described later in this chapter.
- You should not enable automatic dumping to a printer or plotter if there is a logging or stability application running in the other channel. The automatic dump is given priority, and the application in the other channel will be stopped for the duration of the print or plot.

In the case of a logging application, the linearity of the timing information is affected. In the case of a stability application, no new data is recorded while the dump is being made.

- You edit the dump enable using the Modify keys. It can have the values OFF, to disable both the automatic plot and the automatic print, PLOTTER to enable the plot, or PRINTER, to enable the print. The displayed value is always the setting for the dump.
- You can press **Edit** if you have finished editing, or you can press **Next** or **Prev** to edit the other parameter.

START

When you select this parameter, the left side character field shows the message START. The right side character field shows which of the start conditions has been enabled. The application can be started immediately when you press **Exec**, or it can be started when the input power-level is above or below a certain threshold.

- You edit the start condition using the Modify keys. It can have the values IMMEDIAT, to start the application when you press **Exec**, ABOVE to start the application when the input power-level is above a certain threshold, or BELOW, to start the application when the input power-level is below a certain threshold. The displayed value is always the setting for the start condition.
- You can press **Edit** if you have finished editing, or you can press **Next** or **Prev** to edit the other parameter.

THRESHLD

You can only select this parameter when START is set to ABOVE or BELOW. When you select this parameter, the left side character field shows the message THRESHLD. The right side character field shows the threshold that has to be crossed before the application starts taking samples.

- You edit the threshold using the Modify keys. The lower limit is -400.00dBm. The higher limit is 400.00dBm. The displayed value is always the setting for the threshold.
- You can press **Edit** if you have finished editing, or you can press **Next** or **Prev** to edit the other parameters.

Running the Logging Application

To run the application, press **Exec**. You cannot run the application if you are editing parameters. While the application is running, the RUN operation-indicator lights.

While the application is running, the result field shows the sample, and the character field shows the number of samples that have been taken. After all the samples have been taken, the RUN operation- indicator switches off.

Pause suspends the running of the application. You can restart it by pressing **Pause** a second time. When you have pressed pause, you can look at the

parameters set for the application in the Measure mode. You select parameters with **Next** and **Prev**.

Exec stops the application running.

The Manual Logging Application

In the Manual Logging application the instrument takes a sample every time the user presses **Exec**.

When you select the Logging application the character field shows MAN LOGG.

Press **Edit** to look at the existing samples, or to take a sample again. After pressing **Edit** you can select a sample using the Modify keys. While you are editing samples, the EDIT operation- indicator lights. To take a sample again, press **Exec**, the input power-level replaces the power-level logged for the chosen sample.

Press **Edit** if you have finished editing.

Running the Manual Logging Application

While the application is running, the result field shows the input power-level, and the character field shows the number of samples taken.

To take a sample, press **Exec**. When you press **Exec** the result is stored as the next sample.

Example The user is not currently editing samples. The character field shows #61, that is, 61 samples have been taken. On pressing **Exec**, the input power-level is read and stored as sample number 62. #62 is shown in the character field.

While a sample is being taken, the RUN operation-indicator lights.

The Plot Application

In the Plot application the instrument takes the samples from a Stability or Logging application and generates a plot of the samples. You can only plot the samples from the most recent Stability or Logging or Manual Logging application.

To make a plot of the samples you need a HPGL plotter. The plotter must be attached as the only device to the HP-IB connector on the back of the instrument. The device address of the plotter must be set to 5. To output to a plotter the instrument HPIB State must be set to Talk Only (for instructions on how to do this see "MODE" in Chapter 4).

With Firmware revisions 1.7 and greater, to output to a printer or plotter, the instrument HPIB State must be set to Talk Listen.

Note



To find the firmware revision, switch off the instrument, and then hold any key while the instrument is powering up. The firmware revision is shown at the bottom right of the display.

When you select the Plot application the character field shows PLOT. This application has several parameters. AUTOSCAL enables or disables automatic scaling of the plot. Y_MIN sets the minimum value on the y-axis of the plot. Y_MAX sets the maximum value on the y-axis of the plot. COMMENT is an eight character message printed on the plot for identification.

Press **Edit** to look at, or edit the parameters. After pressing **Edit**, you can select parameters using **Next** and **Prev**. While you are editing a parameter, the EDIT operation-indicator lights.

AUTOSCAL

When you select this parameter, the left side character field shows the message AUTOSCAL. The right side character field shows whether automatic scaling has been enabled. If automatic scaling is enabled the instrument decides the best limits for the y-axis by examining the samples.

- You edit the automatic scaling enable using the Modify keys. It can have the value OFF, to disable both automatic scaling, or ON, to enable automatic scaling. The displayed value is always the setting for the scaling.
- You can press **Edit** if you have finished editing, or you can press **Next** or **Prev** to edit the other parameters.

The maximum and minimum values you choose for the graph, when autoscaling is off, are subject to rounding. The final scaling is calculated to give eleven divisions of the y-axis with standard spacings (that is, spacings that are multiples of 1, 2 or 5).

Y_MIN

You can only select this parameter when AUTOSCAL is set to OFF. When you select this parameter, the left side character field shows the message Y_MIN. The right side character field shows the minimum value for the y-axis of the plot.

- You edit the y-axis minimum value using the Modify keys. The lower limit is -800.00dBm. The higher limit is 800.00dBm. The displayed value is always the setting for the minimum.
- You can press **Edit** if you have finished editing, or you can press **Next** or **Prev** to edit the other parameters.

Y_MAX

You can only select this parameter when AUTOSCAL is set to OFF. When you select this parameter, the left side character field shows the message Y_MAX. The right side character field shows the maximum value for the y-axis of the plot.

- You edit the y-axis maximum value using the Modify keys. The lower limit is -800.00dBm. The higher limit is 800.00dBm. The displayed value is always the setting for the maximum.
- You can press **Edit** if you have finished editing, or you can press **Next** or **Prev** to edit the other parameters.

COMMENT

When you select this parameter the left side character field shows the message COMMENT. The right side character field shows the comment string. The comment string is included so that you can identify the plot.

Note



Other applications in the same channel share the COMMENT parameter. Changing this parameter in the Plot application affects the Print application.

- You edit the comment using the **Modify** keys. There are eight characters in the comment and each of these can be a number (0 to 9), a math symbol (-, +), a space, a letter (A to Z), or punctuation symbols (!, ?, ., ,, :, ;, &, |, @, #, \$, %, *, [,], —, or —). The displayed characters are always the setting for the comment.
- You can press **Edit** if you have finished editing, or you can press **Next** or **Prev** to edit the other parameters.

Running the Plot Application

To run the application, press **Exec**. You cannot run the application if you are editing parameters. While the application is running, the RUN operation-indicator lights.

If you try to run the plot without samples or with invalid samples, the message NO DATA, or DATA ?, shows in the character field. The application does not run.

After the plot has finished, the RUN operation-indicator switches off.

Exec stops the application running. The message ABORTED shows in the character field.

Reading the Plot

Figure 3-7 shows a sample plot. The areas on this figure are:

- The HP logo and the instrument number.
- The type of record application that produce the samples. This is one of STABILITY, LOGGING, or MAN LOGG.
- The comment. The message set up in the Plot application is included here on the plot.
- The first column of data contains the parameters set in Measure mode. These are T avg, the averaging time, Cal Fact the calibration factor, Wvl, the wavelength, and Reference, the reference power-level. The reference is not included when the samples were taken as absolute values.
- The second column of data contains the parameters set in Menu mode for the application. These are T total, the period for which the application was taking samples, and Samples, the number of samples taken. Also in this column is the data and time at which the record application was run.

The total time for the logging application consists of the averaging time and the time to process the sample. That is, a sample is only taken after the previous sample has been taken and processed. On the plott, the total time given for the logging application includes both the averaging and the processing time.

 8153A STABILITY 23 DEG.	T avg	1.00 s	T total	99.00 h	Max	-0.0001 dB
	Cal Factor	0.000 dB	Samples	500	Min	-0.0184 dB
	Wavelength	1300.3 nm	05-OCT-90	06:39:42	Diff	0.0183 dB
	Reference	0.700 dBm			Avg	-0.0132 dB

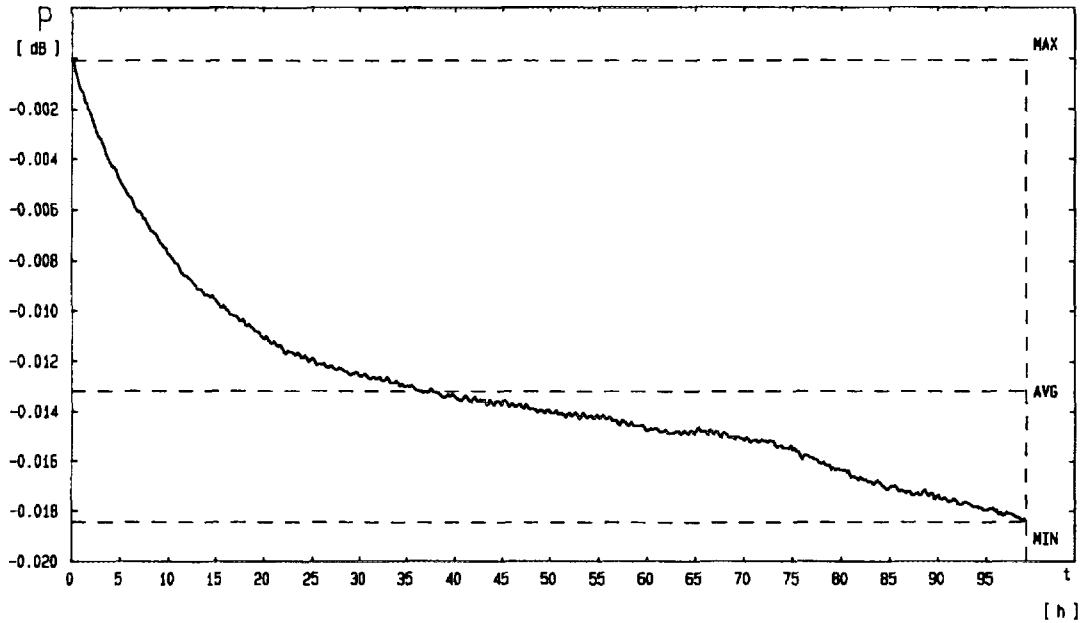

Figure 3-7. Stability Plot

- The third column of data contains statistics based on the samples taken. These are Max, the maximum power-level sampled, Min the minimum power-level sampled, Diff, the difference between the minimum and maximum power-levels sampled, and Avg, the mean average of the samples.

Note

If the samples are taken in dB or dBm, Avg is the mean average of these logarithmic values. If the samples are taken in Watts, Avg is the mean average of the linear values.

 3

- The quantity on the y-axis of the plot is always power. The units can be dBm, dB, or Watts.
- The quantity on the x-axis of the plot is time for the plot of samples from a Stability or a Logging application, or the number of samples for the plot from a Manual Logging application. The units of time can be seconds, minutes or hours.
- The plot is of the power as a function of time for the Stability or Logging applications. The plot is of power as a function of the number of samples taken for the Manual Logging application.
- Horizontal dotted lines are drawn on the plot at the maximum, minimum and average power-levels sampled. A vertical dotted line marks the final sample.

The Print Application

In the Print application the instrument takes the samples from a Stability or Logging application and generates a graphic printout of the samples. You can only printout the samples from the most recent Stability *or* Logging *or* Manual Logging application, in the selected channel.

To make a printout of the samples you need a ThinkJet printer. The printer must be attached as the only device to the HP-IB connector on the back of the instrument. The device address of the printer must be set to 1. To output to a printer the instrument HPIB State must be set to Talk Only (for instructions on how to do this see "MODE" in Chapter 4).

With Firmware revisions 1.7 and greater, to output to a printer or plotter, the instrument HPIB State must be set to Talk Listen.

Note

To find the firmware revision, switch off the instrument, and then hold any key while the instrument is powering up. The firmware revision is shown at the bottom right of the display.

When you select the Print application the character field shows PRINT. This application has several parameters. AUTOSCAL enables or disables automatic scaling of the plot. Y_MIN sets the minimum value on the y-axis of the plot. Y_MAX sets the maximum value on the y-axis of the plot. COMMENT is an eight character message printed on the plot for identification.

Press **Edit** to look at, or edit the parameters. After pressing **Edit**, you can select parameters using **Next** and **Prev**. While you are editing a parameter, the EDIT operation- indicator lights.

AUTOSCAL

When you select this parameter, the left side character field shows the message AUTOSCAL. The right side character field shows whether automatic scaling has been enabled. If automatic scaling is enabled the instrument decides the best limits for the y-axis by examining the samples.

Note



Other applications in the same channel share the AUTOSCAL parameter. Changing this parameter in the Print application affects the Plot application.

- You edit the automatic scaling enable using the Modify keys. It can have the value OFF, to disable both automatic scaling, or ON, to enable automatic scaling. The displayed value is always the setting for the scaling.
- You can press **Edit** if you have finished editing, or you can press **Next** or **Prev** to edit the other parameters.

The maximum and minimum values you choose for the graph, when autoscaling is off, are subject to rounding. The final scaling is calculated to give eleven divisions of the y-axis with standard spacings (that is, spacings that are multiples of 1, 2 or 5).

Y_MIN

You can only select this parameter when AUTOSCAL is set to OFF. When you select this parameter, the left side character field shows the message Y_MIN. The right side character field shows the minimum value for the y-axis of the plot.

Note

Other applications in the same channel share the **Y_MIN** parameter. Changing this parameter in the Print application affects the Plot application.

- You edit the y-axis minimum value using the Modify keys. The lower limit is -800.00dBm. The higher limit is 800.00dBm. The displayed value is always the setting for the minimum.
- You can press **Edit** if you have finished editing, or you can press **Next** or **Prev** to edit the other parameters.

Y_MAX

You can only select this parameter when **AUTOSCAL** is set to **OFF**. When you select this parameter, the left side character field shows the message **Y_MAX**. The right side character field shows the maximum value for the y axis of the plot.

Note

Other applications in the same channel share the **Y_MAX** parameter. Changing this parameter in the Print application affects the Plot application.

- You edit the y-axis maximum value using the Modify keys. The lower limit is -800.00dBm. The higher limit is 800.00dBm. The displayed value is always the setting for the maximum.
- You can press **Edit** if you have finished editing, or you can press **Next** or **Prev** to edit the other parameters.

COMMENT

When you select this parameter the left side character field shows the message **COMMENT**. The right side character field shows the comment string. The comment string is included so that you can identify the plot.

Note

Other applications in the same channel share the **COMMENT** parameter. Changing this parameter in the Print application affects the Plot application.

- You edit the comment using the Modify keys. There are eight characters in the comment and each of these can be a number (0 to 9), a math symbol (-, +), a space, a letter (A to Z), or punctuation symbols (!, ?, ., ,, :, ;, &, |, @, #, \$, %, *, [,], ←, or →). The displayed characters are always the setting for the comment.
- You can press **Edit** if you have finished editing, or you can press **Next** or **Prev** to edit the other parameters.

Running the Print Application

To run the application, press **Exec**. You cannot run the application if you are editing parameters. While the application is running, the RUN operation-indicator lights.

If you try to run the print without samples or with invalid samples, the message NO DATA, or DATA ?, shows in the character field. The application does not run.

After the print has finished, the RUN operation-indicator switches off.

Exec stops the application running. The message ABORTED shows in the character field.

Reading the Printout

The following figure shows a sample of the printout.

APPLICATION PARAMETERS

Application LOGGING
Measurement type CH A (absolute)
Comment DAVE HEG

T avg 200.00 ms
Cal Fact 0.000 dB
Wavelength 1300.0 nm

T total 20.04 s
Samples 100

APPLICATION STATISTICS

Max -3.1071 pW
Min -4.1791 pW
Diff 1.0720 pW
Avg -3.7529 pW

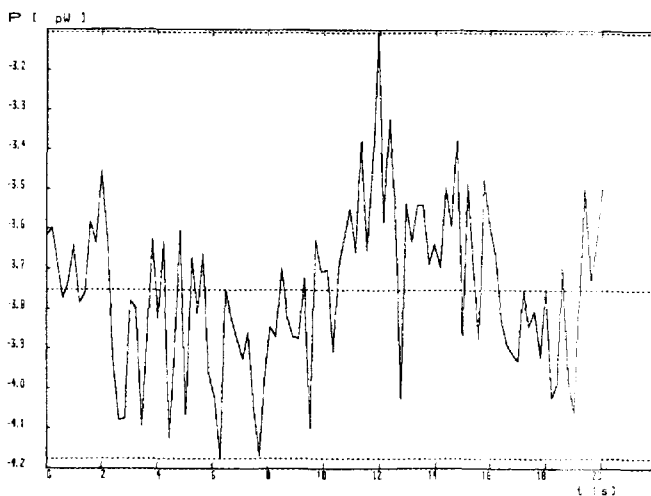

Figure 3-8. Logging Printout

The areas on the figure are:

- The header contains the instrument number. Also in the printout header is the data and time at which the record application was run.
- The application parameters are given in three blocks. In the first block is the type of application that took the samples. This is one of STABILITY, LOGGING, or MANUAL LOGGING.

Note



The length of the window, or the refresh period must be shorter than the rate at which you are changing the polarization, in this case.

Window

3

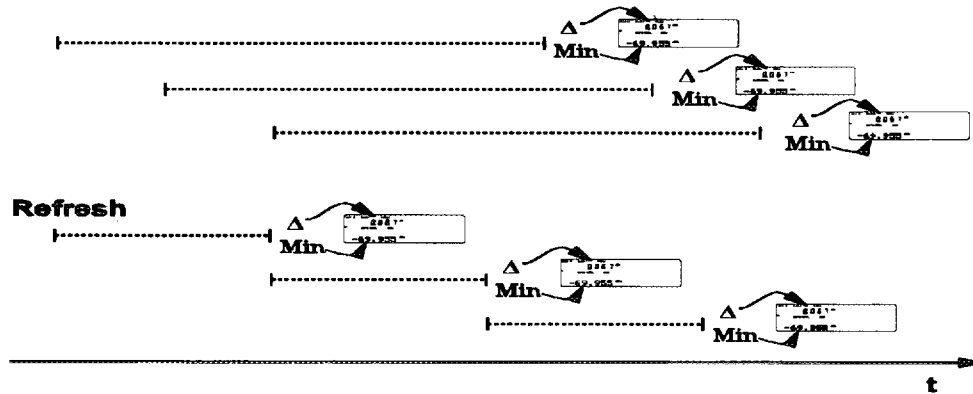

Figure 3-9. The Window and Refresh Modes

MODE

This is the parameter which chooses the mode,

- CONT selects the continuous mode,
- WINDOW selects the Window mode, and
- REFRESH selects the Refresh mode.

SAMPLES

This is the parameter which sets the length of the Window or Refresh mode.

It is possible to use up to 500 samples in the Window mode.

It is possible to use up to 10000 samples in the Refresh mode.

The length of the window or the refresh period is set by the number of samples, and the averaging time. The averaging time is set in Measure mode.

Running the MinMax Application

To run the application, press **Exec**. You cannot run the application if you are editing parameters (press **Edit** again, to finish editing parameters). While the application is running, the RUN operation-indicator lights.

While the application is running, the result field shows the difference between minimum and maximum measurements, and the character field shows the minimum measurement.

Pause suspends the running of the application. While the application is paused, the power level is shown in the result field. You can restart the MinMax application by pressing **Pause** a second time.

Exec stops the application running.

The More Key

More gets you into the other applications. The full list of these applications depends on the modules that you have installed. There are two that are standard, these come with the mainframe. They are the show and the alignment applications.

After pressing **More**, you choose an application using **Next**, **More** or **Prev**. **More** acts in the same way as **Next**. The application is displayed in the character field of the selected channel.

The Show Application

In the Show application you can look at the samples from a Stability or Logging application. You can only look at the samples from the most recent Stability *or* Logging *or* Manual Logging application.

When you select the Show application the character field shows SHOW. This application has no parameters that can be modified.

Press **Edit** to look at the stored values. While you are looking at the stored values, the EDIT operation-indicator lights. To move from one value to another you use **Prev** and **Next**.

3

MAXIMUM

When MAXIMUM shows in the left side character field, the value in the right side character field is the maximum power-level sampled.

MINIMUM

When MINIMUM shows in the left side character field, the value in the right side character field is the minimum power-level sampled.

DIFF

When DIFF shows in the left side character field, the value in the right side character field is the difference between the minimum and maximum power-levels sampled.

AVERAGE

When AVERAGE shows in the left side character field, the value in the right side character field is the mean average of the samples.

Note



If the samples are taken in dB or dBm, Avg is the mean average of these logarithmic values. If the samples are taken in Watts, Avg is the mean average of the linear values.

1

When # 1 shows in the left side character field, the value in the right side character field is the first of the samples taken. To examine the rest of the samples, use the Modify keys. In this case the Modify keys operate on the value in the left side character field.

3

The Alignment Application

The Alignment application simplifies the alignment of two optical components to get the best transfer of power from one to the other.

Preparation

You need a sensor module to perform the Alignment application. The only hardware setup you need is to have the device under test connected to the sensor.

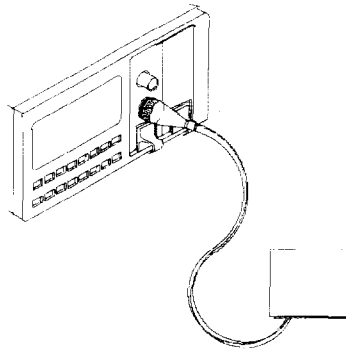

Figure 3-10. Setup for an Alignment Application

Before you start the Alignment application, make sure that you have set all the measurement-parameters that you use. It is most important to make sure that you have set T and λ for the sensor. If you are already in Menu mode, you have to return to Measure mode to set these parameters.

When you select the Alignment application the character field shows ALIGNMNT. This application has several parameters. TYPE sets whether the instrument

↑ is pressed twice.

The left end of the graph represents 0.75dBm. The graph is three dots high.

↓ is pressed once.

The left end of the graph represents 0.50dBm. The graph is five dots high.

If only the last column of dots on the left is lit, the power-level is outside the limits set by $P_{\max} - \Delta P$ and P_{\max}

Pause enables and disables the tone. The frequency of the tone increases with input power-level. The lowest frequency corresponds to the left side of the power graph in the character field. The highest frequency corresponds to the right side of the power graph in the character field. If the power-level is outside the limits set by $P_{\max} - \Delta P$ and P_{\max} , no tone sounds.

Exec stops the application running.



System Mode

System mode is where you set the configurations that affect the instrument as a whole. When you activate system mode, the mode- indicator shows MENU SYS at the top of the display.

4

The Mode Key

Mode selects the operating mode. Pressing this key when in the system mode transfers operation to Measure mode.

Note

The commands described in this chapter can only be used when the instrument is in System mode.

The Modify Keys

See “The Modify Keys” in Chapter 2 for details on how to use the modify keys.

The System Key

System selects the parameter-set for modification. You choose a parameter-set using **Next**, **System** or **Prev**. **System** acts in the same way as **Next**. The current application is displayed in the character field of the current channel.

Note



The configuration information is held in memory until the next time you specifically modify it. It is not affected by the power to the instrument being switched off.

4

RECALL

The recall function sets a channel configuration according to data that has been stored in memory. When you select the recall function, the left side character field shows the message RECALL.

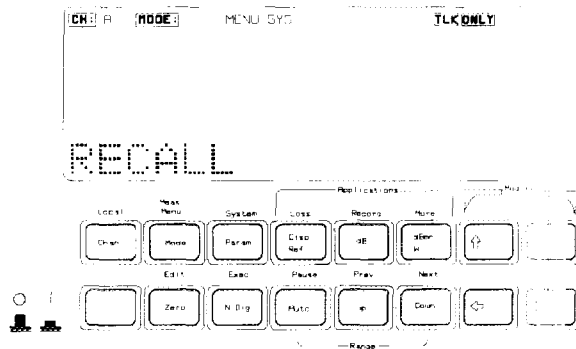

Figure 4-1. Making a Selection in System Mode : the Recall Function

There are three parameters for this function. The module type that the configuration was saved for, the location where the configuration was saved, and the channel to set with the configuration.

Press **Edit** to look at or edit the parameters. All of the parameters are displayed at the same time in the right side character field. You can select between the location and the channel using **←** and **→**. You cannot edit the module type. While you are editing parameters, the mode-indicator shows MENU SYS EDIT.

Press **EXEC** to make a recall of the selected data.

4-2 Local Control - System Mode

The Module Type

The module type is indicated by the last two numeric digits of the product number. Not all locations have a module type. That is, the standard setting, and locations that have not been used to store configuration data do not have a module type parameter. You must have the correct module type in the selected channel to make a recall. If you do not, the message MISMATCH will be shown when you try to make a recall.

The Location

The location where the configuration data is stored is a number between 0 and 9. This number is displayed to the left of the arrow.

You edit the location using the Modify keys. The location used for the recall is the displayed value.

Location 0 always contains the standard setting. The standard setting is:

Parameter	Setting
-----------	---------

Sensor

λ	Module dependant.
CAL	0.000dB.
T	200ms (500ms for Head Interface Module).
REF	1000.0 μ W.
Auto Ranging	Enabled.
Units	Watts
Display	Full Resolution

Source

λ	Module dependant, lower wavelength for dual wavelength source.
ATT	0.0dB.
AUX	CW.
Output	Disabled.

The Channel

This is either the letter A or the letter B. It is displayed to the right of the arrow. You must have the correct module type in the selected channel to make a recall.

If you do not, the message MISMATCH will be shown when you try to make a recall.

You edit the channel using the Modify keys. The channel that will be set by the data is the displayed value.

Example The character field shows the message RECALL '54 3→ A. You press **Exec**. If there is an HP 81554SM in channel A, channel A will be configured according to the data in location 3.

STORE

The store function stores the instrument configuration in memory. When you select the store function, the left side character field shows the message STORE.

There are three parameters for this function. The module type for which the last save to this location was made, the channel for which the information is to be saved, and the location where the data is to be saved.

Press **Edit** to look at or edit the parameters. All of the parameters are displayed at the same time in the right side character field. You can select between the location and the channel using **←** and **→**. You cannot edit the module type. While you are editing parameters, the mode-indicator shows MENU SYS EDIT.

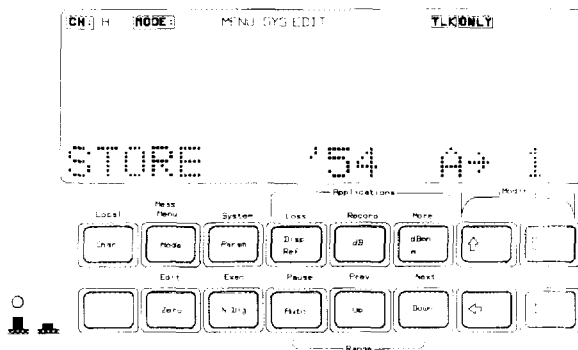

Figure 4-2. Editing a Parameter in System Mode

Press **EXEC** to make a store with the selected parameters.

4-4 Local Control - System Mode

The Module Type

The module type is shown for the last data that was stored in the selected location. If no data has been stored in a location, this information is blank. The module type is indicated by the last two numeric digits of the product number.

The Channel

This is either the letter A or the letter B. It is displayed to the left of the arrow.

You edit the channel using the Modify keys. The channel data that will be saved is the displayed value.

The Location

The location where the configuration data will be stored is a number between 1 and 9. This number is displayed to the right of the arrow.

You edit the location using the Modify keys. The location used for the recall is the displayed value.

Example The character field shows the message STORE '54 3→ A.
You press **(Exec)**.
If there is an HP 81554SM in channel A, channel A will be
configured according to the data in location 3.

HPIB

The HP-IB configuration sets the parameters affecting how the instrument is remotely controlled. When you select the HP-IB configuration, the left side character field shows the message HPIB.

There are three parameters for this configuration. These are ADDRESS, to set the HP-IB address of the instrument, MODE, to set the instrument to control or talk-only operation, and LANGUAGE, to set the type of commands that are used by the instrument.

Press **(Edit)** to look at or edit the parameters. After pressing **(Edit)**, you can select parameters using **(Next)** and **(Prev)**. While you are editing a parameter, the mode-indicator shows MENU SYS EDIT.

ADDRESS

When you select this parameter, the left side character field shows the message ADDRESS. The right side character field shows the setting for the device address of the instrument.

Local Control - System Mode 4-5

There are two parameters for this configuration. These are MM/DD/YY, which sets the date, and HH:MM:SS, which sets the time.

Local Control - System Mode 4-7

You edit the address using the Modify keys. The low limit for the address is 0. The high limit for the address is 30. The address is set to the displayed value.

Press **Edit** to look at or edit the parameters. After pressing **Edit**, you can select parameters using **Next** and **Prev**. While you are editing a parameter, the mode-indicator shows MENU SYS EDIT.

MM/DD/YY

When you select this parameter, the left side character field shows the message **MM/DD/YY**. The right side character field shows the setting for the date, in the format month/day/year.

You edit the date using the Modify keys. The date is set to the displayed value when you edit it.

HH:MM:SS

When you select this parameter, the left side character field shows the message **HH:MM:SS**. The right side character field shows the setting for the time, in the format hours:minutes:seconds.

You edit the time using the Modify keys. The time is set to the displayed value when you edit it.

Example

The time is 11:25:38

You edit the time so that it shows 11:25:58.

The time is set to 11:25:58 as soon as you finish the edit.

Although the display does not change the time itself changes.

To check this you can change to date and then change to time again (by pressing **Next** twice).

Programming the HP 8153A

Introduction

This chapter gives general information on how to control the HP 8153A using the Hewlett-Packard—Interface Bus (HP-IB) and a controller. Descriptions for the actual commands for the HP 8153A, are in the following chapters. Programming information is specific to the HP 8153A, and assumes that you are already familiar with using the HP-IB. If you are not familiar with the HP-IB, then refer to the following books:

- Hewlett-Packard Company. *Tutorial Description of Hewlett-Packard Interface Bus*, 1987.
- The International Institute of Electrical and Electronics Engineers. *IEEE Standard 488.1-1987, IEEE Standard Digital Interface for Programmable Instrumentation*. New York, NY, 1987
- The International Institute of Electrical and Electronics Engineers. *IEEE Standard 488.2-1987, IEEE Standard Codes, Formats, Protocols and Common Commands For Use with ANSI/IEEE Std 488.1-1987*. New York, NY, 1987

To obtain a copy of either of these last two documents, write to:
The Institute of Electrical and Electronics Engineers, Inc.
345 East 47th Street
New York, NY 10017
USA.

The HP 8153A HP-IB Capabilities

The HP 8153A interfaces to the HP-IB as defined by the IEEE Standards 488.1 and 488.2. The table shows the interface functional subset that the HP 8153A implements.

Table 5-1. HP-IB Capabilities

Mnemonic	Function
SH1	Complete source handshake capability
AH1	Complete acceptor handshake capability
T6	Basic talker; serial poll; unaddressed to talk if addressed to listen; no talk only
L4	Basic listener; unaddressed to listen if addressed to talk; no listen only
SR1	Complete service request capability
RL1	Complete remote/local capability
PP0	No parallel poll capability
DC1	Device clear capability
DT1	Device trigger capability (accepted but ignored)
C0	No controller capability
E2	Tristate outputs (except the handshake lines)

5

HP-IB Display Indicators

There are two indicators that you may see in the display when you are controlling the HP 8153A over the HP-IB.

- RMT** lights when the HP 8153A is operating over the HP-IB. While in remote the only key you can use is **Local**. If local lockout is enabled, then you cannot use any keys.
- SRQ** (service request) indicator shows when the HP 8153A has requested service.

5-2 Remote Operation

You cannot control the instrument over the HP-IB if the **TLK ONLY** indicator is lit. If this indicator is lit, see "MODE" in Chapter 4 for details on how to change the HP-IB state.

The Parser

The parser is responsible for reading in messages from the interface, converting them into commands, and then performing those commands.

Normally, the instrument takes all the incoming data from the interface port and puts it in the input queue. When all the data is in the queue, it is parsed.

When the input queue is full, and there are additional bytes at the interface, the parser

1. removes one byte from the input queue
2. parses it,
3. then takes a byte from the interface port and puts it in input queue.

These three steps are repeated until there are no additional bytes at the interface.

Parser Type

Beside the HP 8153A commands, the instrument also has a parser that can use the HP 8152A commands. You can only choose between the parsers from the front panel in system mode, see "LANGUAGE" in Chapter 4.

Synchronization

Most of the commands and queries described are executed when parsed. There are some exceptions for which execution continues afterward. These fall into three categories.

1. Trigger commands.
2. Measurement commands.
3. The Zero command.

These commands block further execution in the same channel until they have finished. Commands in the second channel are executed independently. You can control synchronization for these commands by using the *OPC, *OPC?, and the *WAI commands (see Chapter 6 for more details on these commands).

Note

To make sure that a command has finished executing, check the Operation Complete bit in the Event Status Register.

Clearing the Input Queue

Switching the power off causes commands that are in the input queue, but have not been executed to be lost.

Accepted Characters

The table below lists all the characters allowed by the parser.

Table 5-2. Accepted Characters

Character	Description
HT, LF, CR, space	White spaces
"*"	Block terminator
"+"	Plus sign
" "	Item separator
"_"	Minus sign / Range separator
"."	Decimal point
"0" - "9"	Digits / Integer
","	List terminator
"@" - "Z"	Letters
"a" - "z"	Lower Case Letters

5

HP-IB Bus Commands

The table below shows which HP-IB messages are implemented in the parser.

5-4 Remote Operation

Table 5-3. HP-IB Bus Commands

Command	Description	Treatment
DAB	Data byte	Implemented as usual
DCL	Device clear	Sets 8153 into reset state, see section "The Parser"
EOI	End or identify	End is treated as white space
GET	Group execute trigger	Not implemented
GTL	Go to local	Transparent to the parser
IFC	Interface clear	Transparent to the parser
LAG	Listen address group	Transparent to the parser
LLO	Local lock out	Transparent to the parser
MLA	My listen address	Not implemented
MTA	My talk address	Not implemented
PPC	Parallel poll config.	Not implemented
PPD	Parallel poll disable	Not implemented
PPE	Parallel poll enable	Not implemented
PPU	Parallel poll unconfig.	Not implemented
PPOLL	Parallel poll	Not implemented
REN	Remote enable	Transparent to the parser
SDC	Selected device clear	See DCL
SPD	Serial poll disable	Transparent to the parser
SPE	Serial poll enable	Transparent to the parser
TAD	Talk address	Transparent to the parser
TCT	Take control	Not implemented
UNL	Unlisten	Transparent to the parser
UNT	Untalk	Transparent to the parser

5

Remote Operation 5-5

the combination. Put a semi-colon (;) before a component to indicate another command at the same level of the combination.

Example An example of using colons and semicolons to save typing is
 SOUR:POW:ATT 1.0; STAT ON; WAVE LOW

Remote Operation 5-7

HP-IB Priority

The HP-IB interface has priority over other processes running on the

```
This is the same as
SOURCE:POWER:ATTENUATION 1.0
SOURCE:POWER:STATE ON
SOURCE:POWER:WAVELENGTH LOWER
```

A semi-colon followed by a colon (;:) sets the path back to the root level.

The command can be written in upper case or in lower case.

The components can be typed in full, or they can be shortened. The full version is in the command table in both upper and lower case letters. The shortened version of a command is that part which is shown in upper case.

Example The command
SOURCE:POWER:STATE ON
can also be written in lower case as
source:power:state on
or it can be shortened and written as
sour:pow:stat on

5

Setting the HP-IB Address

You can only set the HP-IB address from the front panel. See "ADDRESS" in Chapter 4.

The HP-IB refuses to accept a new HP-IB address if it is in the remote state, or if it is addressed either as a listener or as a talker. Return the HP 8153A to local control (via controller) before changing the address.

The default HP-IB address is 22.

Syntax Diagram Conventions

The following symbols describe the syntax of commands in the following chapters.

< ... >	The characters between angled brackets show the kind of data that you require, or that you get in a response. You do not type the angled brackets in the actual message.
application	is an application name. The names which are available depend upon the modules installed.
boolean	this can be data (ON or OFF), or a number. Any non-zero value is an ON. In a response you get 0, for OFF, or 1, for ON.
day	is a number in the range 1 to 28, 1 to 29, 1 to 30 or 1 to 31. It is the day of the month in the date. The range used depends on the values of "year" and "month" parameters.
hour	is a number in the range 0 to 23. It is the hours in the time.
minute	is a number in the range 0 to 59. It is the minutes in the time.
month	is a number in the range 1 to 12. It is the month in the date.
node	is a node name. A node is the name of a position in the structure of the status registers.
second	is a number in the range 1 to 60. It is the seconds in the time. Setting second to 60 will automatically increment the other elements of the time.
string	is ascii data.
unit	is one of DB, DBM, W (Watts), M (meters), or S (seconds), or one of NW or MW, NM, or MS. It is the units in a value.
value	is numeric data in one of the forms described below (NR1, NR2, NR3, or NRf).

varname is the name of a variable for use with an application. The varname available depend on the application.

wsp is a white space.

year is a number in the range 1990 to 2089. This is the years in the date.

Other kinds of data are described as required.

[...] The characters between square brackets show optional information that you can include with the message.

| The bar shows an either-or choice of data, for example, *a|b* means either *a* or *b*, but not both simultaneously.

All characters not between angled brackets are terminal symbols and must be sent exactly as shown. Items between angled brackets are non-terminal symbols, descriptions of these items follow the syntax description. Spaces are ignored; they can be inserted to improve readability.

The response format specifies what the instrument returns in response to a query. All responses are terminated with a <line feed> with the HP-IB EOI (bus management line) active.

There are four types of number that are used in responses. These are defined by the IEEE standard.

NR1 This is a number of the form $[+|-]number$ where number is any number of digits without a decimal point.

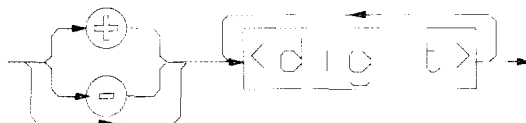

Examples of NR1 are 3, +27, -56.

NR2 This is a number of the form $[+|-]number.number$, where number is any number of digits without a decimal point.

5-10 Remote Operation

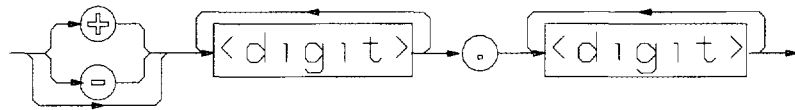

Examples of numbers in NR2 format are 33.23, +15.02376, -123.098.

NR3

This is a number of the form $[+|-]number.numberE+|-number$, where number is any number of digits without a decimal point.

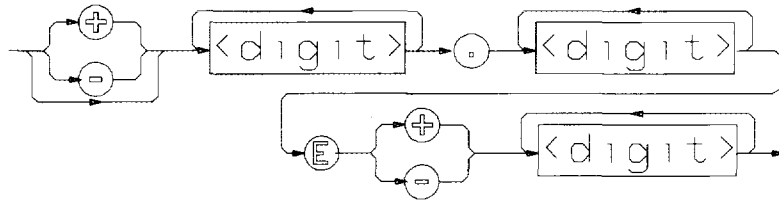

Examples of numbers in NRf format are 3.27E-56, +33.32E+15, -0.2376E-11.

NRf

is a number with any of the formats described above.

In this manual we use these format types to describe entered data as well as response data. A general description of entered data is given in the diagram here

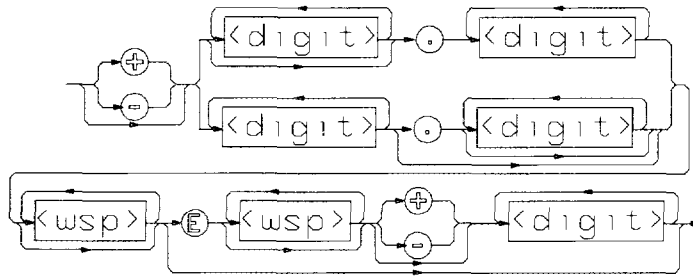



Common Commands

The IEEE 488.2 standard has a list of reserved commands, called these common commands. Some of these commands must be implemented by any instrument using the standard, others are optional. The HP 8153A implements all the necessary commands, and some optional ones. This chapter describes the implemented commands.

Common Status Information

There are four registers involved in the status information available from the instrument when you use the common commands. Two of these are status-registers and two are enable-registers. These registers conform to the *IEEE Standard 488.2-1987*. You can find further descriptions of these registers under “*ESE”, “*ESR?”, “*SRE”, and “*STB?”.

The following figure shows how the registers are organized.

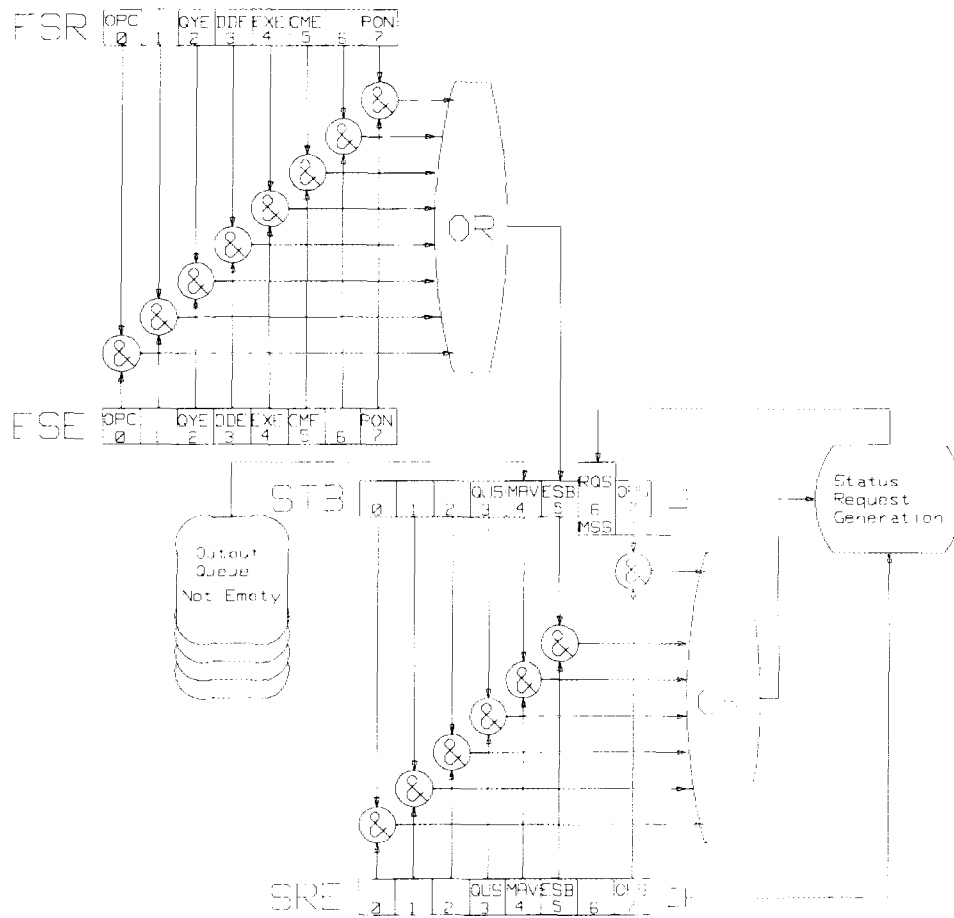

Figure 6-1. Common Status Registers

Note

Unused bits in any of the registers return 0 when you read them.



6-2 Remote Operation - Common Commands

SRQ, The Service Request

A service request (SRQ) is forced when a bit in the Status Byte register goes from 0 → 1 AND the corresponding Service Request Enable Mask bit is set.

If an SRQ is forced, the Request Service (RQS) bit is set to 1. This bit remains at 1 until read by a serial poll, even if the reason or condition that caused the service request no longer exists. Similarly, if a serial poll reads the RQS it is reset to 0, even if the condition that caused the service request still exists. The serial poll command transfers the value of the Status Byte register to a variable.

Input Queue

The input queue is a FIFO queue (first-in first-out) and is 1024 bytes long.

Output Queue

The output queue is a FIFO queue (first-in first-out) and is 274 bytes long.

The message available, Message Available (MAV), bit is set in bit four of the Status Byte register whenever the output queue is not empty. Receiving a new program message clears the output queue and the Message Available (MAV) bit. This happens directly after the program message terminator is received.

Error Queue

The error queue is a FIFO queue (first-in first-out) and is 30 errors long. That is, the oldest error is the first error to be read.

If the queue overflows, message '-350 <too many errors>' overlays the last message in the queue.

Table 6-1. Common Command Summary

Command	Function
*CLS	Clear Status Command
*ESE	Standard Event Status Enable Command
*ESE?	Standard Event Status Enable Query
*ESR?	Standard Event Status Register Query
*IDN?	Identification Query
*OPC	Operation Complete Command
*OPC?	Operation Complete Query
*RST	Reset Command
*SRE	Service Request Enable Command
*SRE?	Service Request Enable Query
*STB?	Read Status Byte Query
*TRG	Trigger Command
*TST?	Self Test Query
*WAI	Wait Command

6

***CLS**

Clear Status command.

Syntax *CLS

Definition The *CLS command clears all the event registers summarized in the Status Byte register. With the exception of the output queue, all queues that are summarized in the Status Byte register are emptied. The error queue is also emptied. Neither the Standard Event Status Enable register, nor the Service Request Enable register are affected by this command.

After the *CLS command the instrument is left in the idle state. The command does not alter the instrument setting. *OPC/*OPC? actions are canceled.

Related Command Interface Command SDC

6-4 Remote Operation - Common Commands

Example OUTPUT 722;"*CLS"

***ESE**

standard Event Status Enable command.

Syntax *ESE <wsp> <value>
 0 ≤ value ≤ 255

Definition The *ESE command sets bits in the Standard Event Status Enable register and thus enables the corresponding bits in the Standard Event Status register. A 1 in a bit in the enable register enables the same bit in the status register. The value sent as an integer or a floating point number (Nrf).

The register is cleared at power-on. The *RST and *CLS commands do not change the register.

Table 6-2.
The Standard Event Status Enable Register

BIT	MNEMONIC	Decimal Value
7	Power On	128
6	Not used	0
5	Command Error	32
4	Execution Error	16
3	Device Dependent Error	8
2	Query Error	4
1	Not used	0
0	Operation Complete	1

6

Related Commands *ESE?

Example OUTPUT 722;"*ESE 21"

***ESE?**

standard Event Status Enable query.

Syntax ***ESE?**

Response <value>

$0 \leq \text{value} \leq 255$

Definition The ***ESE?** query returns the contents of the Standard Event Status Enable register (see "***ESE**" for information on this register). The value is returned as an integer (NR1).

Related Commands ***ESE**

Example OUTPUT 722; "***ESE?**"
 ENTER 722; A\$

***ESR?**

standard Event Status Register query.

Syntax ***ESR?**

Response <value>

$0 \leq \text{value} \leq 255$

6

Table 6-3.
The Standard Event Status Register

BITS	MNEMONICS	Decimal Value
7	Power On	128
6	Not used	0
5	Command Error	32 ^[1]
4	Execution Error	16 ^[2]
3	Device Dependent Error	8 ^[3]
2	Query Error	4 ^[4]
1	Not used	0
0	Operation Complete	1

- [1] See "Command Errors" in Appendix I
- [2] See "Execution Errors" in Appendix I
- [3] See "Device Dependant Errors" in Appendix I
- [4] See "Query Errors" in Appendix I

Definition The *ESR? returns the contents of the Standard Event Status register. The register is cleared after being read. The value is returned as an integer (NR1).

Example OUTPUT 722;"*ESR?"
ENTER 722; A\$

***IDN?**

IDeNtification query.

Syntax *IDN?

Response HEWLETT-PACKARD, 8153A, 0, 1.0

HEWLETT-PACKARD: manufacturer

8153A: instrument model number

0: means that serial numbers,
are not provided.

1.0: firmware revision level

Definition The *IDN? query gets the instrument identification over the interface.

Related Commands *OPT?.

Example DIM A\$ [30]
OUTPUT 722;"*IDN?"
ENTER 722; A\$

***OPC**

Operation Complete command.

Syntax *OPC

Definition The *OPC command parses all program message units in the input queue and sets the operation complete bit in the Standard Event Status register, when the contents of the input queue have been processed.

The following actions cancel the *OPC command (and put the instrument into Operation Complete, Command Idle State):

- Power-on
- the Device Clear Active State is asserted on the interface.
- *CLS
- *RST

Related Commands *OPC?, *WAI

Example OUTPUT 722;"*CLS;*ESE 1;*SRE 32"
OUTPUT 722;"*OPC"

6-8 Remote Operation - Common Commands

***OPC?**

OPeration Complete query.

Syntax ***OPC?**

Response <value>

value = 1

Definition The ***OPC?** command parses all program message units in the input queue, sets the operation complete bit in the Standard Event Status register, and places an ASCII '1' in the output queue, when the contents of the input queue have been processed.

The following actions cancel the ***OPC?** query (and put the instrument into Operation Complete, Command Idle State):

- Power-on
- the Device Clear Active State is asserted on the interface.
- ***CLS**
- ***RST**

Related Commands ***OPC, *WAI**

Example **OUTPUT 722; "*OPC?"**
ENTER 722; A\$

Note that this query prevents the use of the input queue because it is immediately followed by an ENTER command. The ENTER command will not execute until it receives data from the output queue.

***OPT?**

OPTion identification query.

Syntax ***OPT?**

Response <string> , <string>

The string contains the product number of the module in the channel. The first string returns the module in

channel A, the second string returns the module in channel B. `EMPTY` is returned if a slot contains no module.

Definition The `*OPT?` query gets the instrument to identify its installed options over the interface.

Related Commands `*IDN?`.

Example
`DIM A$ [20]`
`OUTPUT 722; "*OPT?"`
`ENTER 722; A$`

If the installed modules were a HP 81554SM and a HP 81530A, the returned string would be `HP81554SM,HP81530A`.

***RST**

ReSeT command.

Syntax `*RST`

Definition The `*RST` command sets the instrument to reset setting (standard setting) stored in ROM.

Pending `*OPC/*OPC?` actions are canceled.

Instrument state: the instrument is placed in the idle state awaiting a command.

The `*RST` command clears the key queue.

The following are not changed:

- HP-IB (interface) state
- Instrument interface address
- Output queue
- Service Request Enable register (SRE)
- Standard Event Status Enable register (ESE)

The following table lists the commands and parameters of the reset state.

Table 6-4. Reset State (Standard Setting)

Commands	Parameters (Default)	Notes
DISPlay:BRIGhtness	1	
DISPlay:STATe	ON	
SENSe:POWer:ATIME	200MS	sensor only
SENSe:POWer:RANGe:AUTO	ON	sensor only
SENSe:POWer:WAVElength		module dependent
SENSe:POWer:REFerence	TOREF, 0dBm	sensor only
SENSe:POWer:REFerence	TOB, 0	two sensors only
SENSe:POWer:REFerence	TOA, 0	two sensors only
SENSe:POWer:REFerence:STATe	OFF	sensor only
SENSe:POWer:REFerence:STATe:RATIo	TOREF	sensor only
SENSe:POWer:UNIT	W	sensor only
SENSe:CORRection	0.0DB	sensor only
ABORt		sensor only
ABORt2		Ch. B sensor only
INITiate:CONTInuous	OFF	sensor only
INITiate2:CONTInuous	OFF	Ch. B sensor only
SOURce:AM:INTernal:FREQUency	CW	source only
SOURce:POWer:ATTenuation	0.0DB	source only
SOURce:POWer:ATTenuation2	0.0DB	dual λ source
SOURce:POWer:STATe	OFF	source only
SOURce:POWer:WAVElength	LOWER	dual λ source

Example OUTPUT 722; "*RST"

***SRE**

Service Request Enable command.

Syntax *SRE <wsp> <value>

0 ≤ value ≤ 255

Definition

The *SRE command sets bits in the Service Request Enable register. A 1 in a bit in the enable register enables the corresponding bit in the status register. The value sent as an integer or a floating point number (NRf).

The register is cleared at power-on. The *RST and *CLS commands do not change the register.

Table 6-5. The Service Request Enable Register

BITS	MNEMONICS	Decimal Value
7	Operation Status	128
6	Request Service (RQS)/Master Summary Status (MSS)	64
5	Event Status Bit (ESB)	32
4	Message Available (MAV)	16
3	Questionable Status	8
2	Not used	0
1	Not used	0
0	Source Status	1

Related Commands *SRE?, *STB?

Example OUTPUT 722;"*SRE 48"

***SRE?**

Service Request Enable query.

Syntax *SRE?

Response $0 \leq \text{value} \leq 255$

Definition The *SRE? query returns the contents of the Service Request Enable register. (See "*SRE" for information on the Service Request Enable register). The value is returned as an integer (NR1).

Related Commands *SRE, *STB?

Example OUTPUT 722;"*SRE?"
ENTER 722; A\$

***STB?**

Status Byte query.

Syntax

***STB?**

Response

<value>

$0 \leq \text{value} \leq 255$

Table 6-6. The Status Byte Register

BITS	MNEMONICS	Decimal Value
7	Operational Status	128
6	Master Summary Status (MSS)	64
5	Event Status Bit (ESB)	32
4	Message Available (MAV)	16
3	Questionable Status	8
2	Not used	0
1	Not used	0
0	Source Status	0

Definition

The ***STB?** query returns the contents of the Status Byte register. The register is programmed via the Service Request Enable Mask. For setting this mask, see "***SRE**". The value is returned as an integer (NR1).

The **STATUS** commands find the exact cause of an error. These are described in Chapter 7.

The Master Summary Status (MSS) bit is true when any enabled bit of the STB register is set (excluding Bit 6).

The Status Byte register including, the master summary bit, MSS, is not directly altered because of an ***STB?** query.

Related Commands

***SRE, *SRE?**

Example

OUTPUT 722; "***STB?**"

ENTER 722; A\$

***TRG**

TRiGger command.

Syntax ***TRG**

Definition The ***TRG** command has the same effect as the interface command "Group Execute Trigger" (GET). The command triggers any event that was suspended waiting for a trigger.

Related Commands Interface Command GET, INIT, INIT:CONT, INIT:CONT?

Example OUTPUT 722; "*TRG"

***TST?**

self-TeST query.

Syntax ***TST?**

Response <value>

value = 0|1

A value of zero means no errors.

Definition The ***TST?** query makes the instrument perform a self-test and place the results of the test in the output queue.

No further commands are allowed while the test is running. After the self-test the instrument is returned to the setting that was active at the time the self-test query was processed.

Example OUTPUT 722; "*TST?"
ENTER 722; A\$

***WAI**

WAIt command.

Syntax ***WAI**

Definition The ***WAI** command prevents the instrument from executing any further commands until the current command has finished executing. All pending operations are completed during the wait period.

Related Commands *OPC, *OPC?
Example OUTPUT 722;"*WAI"



HP-IB Status Commands

This chapter gives a list of the HP 8153A HP-IB commands and queries used for determining the status of the instrument.

The Status Registers

The building blocks of the status information circuitry are three types of register, and two kinds of transition filters. These registers and filters are grouped together to make a node. Each node has a condition register, a positive transition register, a negative transition register, an event register and an enable register.

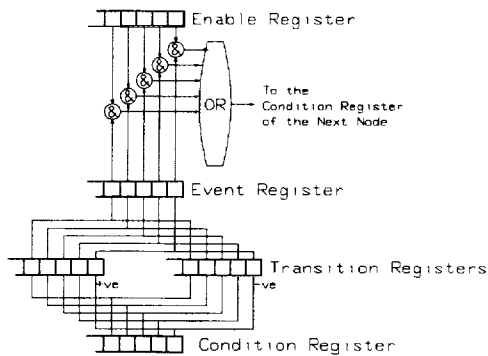

Figure 7-1. The Registers and Filters in a Node

Note



The most significant bit of these registers is not used. That is, these registers use only bits 0 to 14.

The Condition Registers

You can read a condition register at any time to find the current status of the node. It is updated continuously. Reading a condition register does not change its contents.

The Transition Filters

The transition filters are of two types, a positive transition filter and a negative transition filter. A 1 in a bit of the transition filter enables that bit.

An enabled bit in a positive transition filter generates a 1 at the output when the input goes from 0 to 1.

An enabled bit in a negative transition filter generates a 1 at the output when the input goes from 1 to 0.

The condition register provides the input to the filters. The output is sent to the event register.

At power up, all of the bits in both transition registers are set to 0. That is, no transitions are passed to the event registers.

The Event Registers

The outputs from the transition filters set the bits in the event register. These bits are only cleared when the register is read, otherwise they stay as they are.

The Enable Registers

The enable register selects which bits affect the next stage of registers. A 1 in a bit in the enable register, means that the corresponding bit in the event register is enabled. The enabled bits are ORed together and the result is sent to the condition register in the next node.

At power up, all of the bits in the enable registers are set to 0.

7

The Status Commands

The registers and filters described above, are present in each node of the status structure (the full structure is given later in this chapter). Each node has the same set of commands and queries. These commands and queries are listed here once to avoid repetition.

Note



You can only use these commands and queries with a node specification. The syntax element <node> means any of the node specifications.

Note



- The commands and queries are given in upper and lower case. You can use either the entire command or query (both upper and lower case), or just the part that is in upper case. That is, either `STATUS:OPERATION:SETTLING:EVENT?` or `STAT:OPER:SETT:EVEN?` is acceptable.
- The commands and queries can be entered in either upper or lower case. That is either `STAT:OPER:SETT:EVEN?` or `stat:oper:sett:even?` is acceptable.

STATus:PRESet

Syntax

STATus:PRESet

Note



You do not specify a node with this command.

Description

This command presets all the enable registers and transition filters for all nodes of the OPERational and QUEStionable status.

The OPERational, QUEStionable, and ISUMmary nodes are set:

Register	All bits set to
ENABLE	0
PTRansition	1
NTRansition	0

The OPERATION:CORRECTing:ZERO, OPERATION:AVERaging:POWER, OPERATION:MEASure:POWER and any OPERATION:POWER:<application> nodes are set:

Register	All bits set to
ENABLE	1
PTRansition	0
NTRansition	1

All other nodes are set:

Register	All bits set to
ENABLE	1
PTRansition	1
NTRansition	0

7

Related Commands None.

Example OUTPUT 722;"STAT:PRES"

STATus:<node>:CONDition?

Syntax STATus:<node>:CONDition?

Response <value>

$0 \leq \text{value} \leq 32767$

Description This query returns the value for the condition register for the node. The value is returned as an integer (NR1).

Related Commands None.

7.4 Remote Operation - Status Commands

Example OUTPUT 722;"STAT:OPER:TRIG:POW:COND?"
 ENTER 722;A\$

STATus:<node>:ENABLE

Syntax STATus:<node>:ENABle <value>
 $0 \leq \text{value} \leq 32767$

Description This command sets the enable register for the node. You send the value as an integer (NRf). A 1 in any bit of this register enables that bit in the event register. All the enabled bits are ORed together and the result of this OR is sent to the next node.

Related Commands STAT:<node>:ENAB?

Example OUTPUT 722;"STAT:OPER:TRIG:POW:ENAB 3"

STATus:<node>:ENABLE?

Syntax STATus:<node>:ENABle?

Response <value>
 $0 \leq \text{value} \leq 32767$

Description This query returns the setting for the enable register for the node. The value is returned as an integer (NR1).

Related Commands STAT:<node>:ENAB

Example OUTPUT 722;"STAT:QUES:POW:ENAB?"
 ENTER 722;A\$

STATus:<node>[:EVENT]?

Syntax STATus:<node>[:EVENT]?

Response <value>
 $0 \leq \text{value} \leq 32767$

Description This query returns the value for the event register for the node. The value is returned as an integer (NR1). Once you have read the event register, its contents are cleared.

Related Commands None.

Example OUTPUT 722;"STAT:OPER:SETT:EVEN?"
ENTER 722;A\$

STATus:<node>:NTRansition

Syntax STATus:<node>:NTRansition <value>
 $0 \leq \text{value} \leq 32767$

Description This command sets the negative transition filter for the node. You send the value as an integer (NRf). A 1 in any bit of this register enables the negative transition. That is, if a bit is set to 1 and the corresponding bit at the input changes from 1 to 0, the output goes to 1.

Related Commands STAT:<node>:NTR?

Example OUTPUT 722;"STAT:QUES:POW:OVERR:NTR 3"

STATus:<node>:NTRansition?

Syntax STATus:<node>:NTRansition?

Response <value>
 $0 \leq \text{value} \leq 32767$

Description This query returns the value for the setting of the negative transition filter for the node. The value is returned as an integer (NR1).

Related Commands STAT:<node>:NTR

Example OUTPUT 722;"STAT:QUES:ISUM:INST1:NTR?"
ENTER 722;A\$

STATus:<node>:PTRansition

Syntax STATus:<node>:PTRansition <value>
 $0 \leq \text{value} \leq 32767$

Description This command sets the positive transition filter for the node. You send the value as an integer (NRf). A 1 in any bit of this register enables the negative transition. That is,

if a bit is set to 1 and the corresponding bit at the input changes from 0 to 1, the output goes to 1.

Related Commands STAT:<node>:PTR?

Example OUTPUT 722;"STAT:QUES:POW:PTR 3"

STATus:<node>:PTRansition?

Syntax STATus:<node>:PTRansition?

Response <value>

$0 \leq \text{value} \leq 32767$

Description This query returns the value for the setting of the positive transition filter for the node. The value is returned as an integer (NR1).

Related Commands STAT:<node>:PTR

Example OUTPUT 722;"STAT:QUES:POW:OVERR:PTR?"
ENTER 722;A\$

The Operation Status

The operation status is that part of the status structure that shows the normal operation of the instrument. The relationship between the nodes of the operation status is shown in Figure 7-2. Each node (except the status byte) is sixteen bits wide. Only 15 of these bits are used. Each node (except the status byte) has its own condition, event and enable registers, and its own transition filters. These registers and filters are described earlier in this chapter.

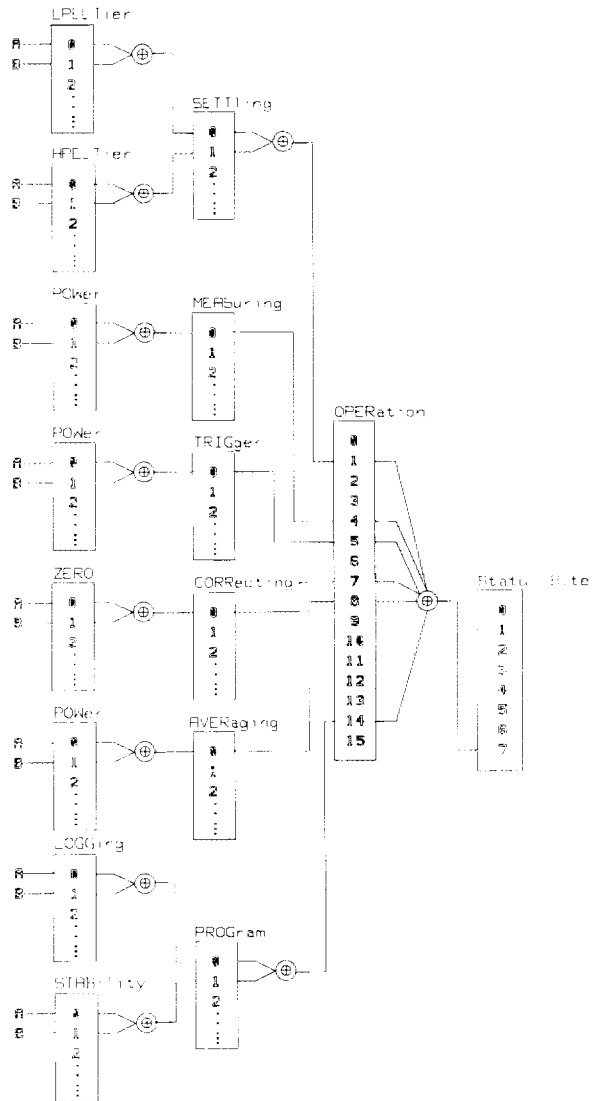

Figure 7-2. The Operation Registers

7

7-8 Remote Operation - Status Commands

The Operation Status Commands

The following is a complete list of the operation status commands and queries. These commands and queries are available, without regard to the configuration of the instrument. Some nodes are only active with certain modules. For example, the averaging registers are not used if the instrument has two source modules. Here, you can read the averaging event register, but it always returns a 0.

Table 7-1. STATUS Command Summary

Command	Parameter
‡ is being used as shorthand for	
:CONDition?	
:ENABle	
:ENABle?	<value>
[:EVENT]?	
:NTRansition	<value>
:NTRansition?	
:PTRansition	<value>
STATUS	
:OPERation ‡	
:SETTling ‡	
:LPELTier ‡	
:HPELTier ‡	
:MEASuring ‡	
:POWer ‡	
:TRIGger ‡	
:POWer ‡	
:CORRecting ‡	
:ZERO ‡	
:AVERaging ‡	
:POWer ‡	
:PROGram ‡	
:<application> ‡	

The OPERation node

Here we deal with each node. Refer to "The Status Commands" as well as this section, to build a full description of the commands and queries that are available.

Note Unused bits in any of the registers return 0 when you read them.



The OPERation node gives a summary of the other operation nodes.

The OPERation Node		
BIT	MNEMONIC	Decimal Value
15	Not used	0
14	PROGram Node	16384
13	Not used	0
12	Not used	0
11	Not used	0
10	Not used	0
9	Not used	0
8	AVERaging Node	256
7	CORRecting Node	128
6	Not used	0
5	TRIGger Node	32
4	MEASuring Node	16
3	Not used	0
2	Not used	0
1	SETTling Node	2
0	Not used	1

A 1 means this operation is taking place, or has taken place. Bit 7 of the status byte summarizes this node.

The OPERATION:SETTLing Node

This node gives a summary of the peltier settling nodes. Bit 0 returns the status of the LPELTier node. Bit 1 returns the status of the HPELTier node. The HPELTier node is only active for a dual wavelength source module, the other modules use only LPELTier. A 1 means that the instrument is settling or has settled. Bit 1 of the OPERATION node summarizes this node.

The OPERATION:SETTLing:LPELTier Node

This node gives a summary of the peltier settling. Bit 0 returns the status of the peltier settling of the module in channel A. Bit 1 returns the status of the peltier settling of the module in channel B. A 1 means that the module is settling or has settled. Bit 0 of the OPERATION:SETTLing node summarizes this node.

The OPERATION:SETTLing:HPELTier Node

This node gives a summary of the peltier settling for the higher wavelength of a dual wavelength source. Bit 0 returns the status of the peltier settling for the higher wavelength of the module in channel A. Bit 1 returns the status of the peltier settling for the higher wavelength of the module in channel B. A 1 means that the module is settling or has settled. Bit 1 of the OPERATION:SETTLing node summarizes this node.

The OPERATION:MEASuring Node

This node gives a summary of the measuring status. Bit 0 returns the status of the POWER node. Bit 4 of the OPERATION node summarizes this node.

The OPERATION:MEASuring:POWER Node

This node gives a summary of the power measurements. Bit 0 returns the status of the power measuring of the module in channel A. Bit 1 returns the status of the power measuring of the module in channel B. a 1 means that a power measurement is taking place or has taken place. Bit 0 of the OPERATION:MEASuring node summarizes this node.

The OPERATION:TRIGger Node

This node gives a summary of the triggering status. Bit 0 returns the status of the POWER node. A 1 means that the instrument is triggering, or has been triggered. Bit 5 of the OPERATION node summarizes this node.

The OPERATION:TRIGger:POWER Node

This node gives a summary of the triggering. Bit 0 returns the status of the triggering of the module in channel A. Bit 1 returns the status of the triggering of the module in channel B. A 1 means that the instrument is triggering, or has been triggered. Bit 0 of the OPERATION:TRIGger node summarizes this node.

The OPERATION:CORRecting Node

This node gives a summary of the correcting status. Bit 0 returns the status of the ZERO node. A 1 means that a correction is being made, or has been made. Bit 7 of the OPERATION node summarizes this node.

The OPERATION:CORRecting:ZERO Node

This node gives a summary of the zeroing, that is the removal of electrical offsets. Bit 0 returns the status of the zeroing of the module in channel A. Bit 1 returns the status of the zeroing of the module in channel B. A 1 means that zeroing is taking place, or has taken place. Bit 0 of the OPERATION:CORRecting node summarizes this node.

The OPERATION:AVERaging Node

This node gives a summary of the averaging status. Bit 0 returns the status of the POWER node. A 1 means that readings are being averaged, or have been averaged. Bit 8 of the OPERATION node summarizes this node.

The OPERATION:AVERaging:POWER Node

This node gives a summary of the power averaging, that is the result is an average of a number of results. Bit 0 returns the status of the averaging of the module in channel A. Bit 1 returns the status of the averaging of the module in channel B. A 1 means that averaging is taking place, or has taken place. Bit 0 of the OPERATION:AVERaging node summarizes this node.

The OPERation:PROGram Node

This node gives a summary of the application status. Each bit returns the status of an <application> node. Bit 0 represents the LOGGing application. Bit 1 represents the STABility application. Module applications are returned in other bits. The bit used by a module application is available with each the module. A 1 means that the application is running, or has been run. Bit 14 of the OPERation node summarizes this node.

The OPERation:PROGram:<application> Node

This node gives a summary of the application. Bit 0 returns the status for this application in channel A. Bit 1 returns the status for this application in channel B. A 1 means that this application is running, or has run.

The Questionable Status

The questionable status is that part of the status showing an abnormal state in the operation of the instrument. The relationship between the nodes is shown in the following figure. Each node (except the status byte) is sixteen bits wide. Only 15 of these bits are used. Each node (except the status byte) has it's own condition, event and enable registers, and it's own transition filters.

7

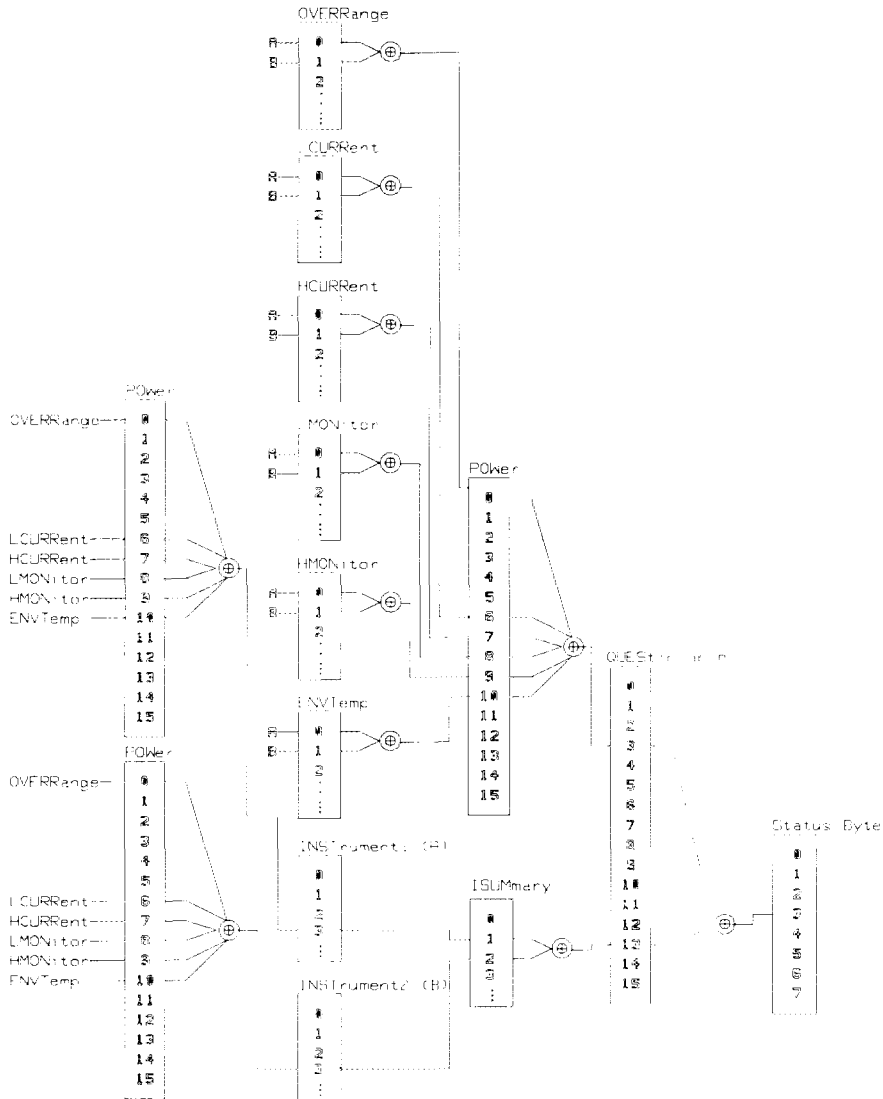

Figure 7-3. The Questionable Registers

7-14 Remote Operation - Status Commands

The Questionable Status Commands

The following is a complete list of the questionable status commands and queries. These commands and queries are available, without regard to the configuration of the instrument.

Table 7-2. STATUS Command Summary

Command	Parameter
‡ is being used as shorthand for	
:CONDition?	
:ENABle	
:ENABle?	<value>
[:EVENT]?	
:NTRansition	<value>
:NTRansition?	
:PTRansition	<value>

STATUS

```

:QUEStionable ‡
:POWer ‡
:OVERRange ‡
:LCURRent ‡
:HCURRent ‡
:LMONitor ‡
:HMONitor ‡
:ENVTemp ‡
:ISUMmary ‡
:INSTRument[1|2] ‡
:POWer ‡

```

The QUEStionable node

Here we deal with each node. Refer to "The Status Commands" as well as this section, to build a full description of the commands and queries that are available.

Note Unused bits in any of the registers return 0 when you read them.



The QUEStionable node gives a summary of the other questionable nodes.

The QUEStionable Node		
BIT	MNEMONIC	Decimal Value
15	Not used	0
14	Not used	0
13	ISUMmary Node	8192
12	Not used	0
11	Not used	0
10	Not used	0
9	Not used	0
8	Not used	0
7	Not used	0
6	Not used	0
5	Not used	0
4	Not used	0
3	POWER Node	8
2	Not used	0
1	Not used	0
0	Not used	0

A 1 means that there is an error condition, or there has been one. Bit 3 of the status byte summarizes this node.

The QUESTIONable:POWER Node

This node gives a summary of the power nodes.

The QUESTIONable:POWER Node

BIT	MNEMONIC	Decimal Value
15	Not used	0
14	Not used	0
13	Not used	0
12	Not used	0
11	Not used	0
10	ENVTemp	1024
9	HMONitor	512
8	LMONitor	256
7	HCURRent	128
6	LCURRent	64
5	Not used	0
4	Not used	0
3	Not used	0
2	Not used	0
1	Not used	0
0	OVERRange	1

A 1 means that there is a problem, or has that there has been one. Bit 3 of the QUESTIONable node summarizes this node.

The QUESTIONable:POWER:OVERRange Node

This node gives a summary of the power overrange status. Bit 0 returns the status of the power overrange of the module in channel A. Bit 1 returns the status of the power overrange of the module in channel B. This node deals only with sensor modules. A 1 means that power is overrange is taking place, or was overrange. This node is summarized in bit 0 of the QUESTIONable:POWER node.

The QUESTIONable:POWER:LCURRENT Node

This node gives a summary of the laser current. For a dual wavelength source, this is the current for the lower wavelength laser. Bit 0 returns the status of the current for the module in channel A. Bit 1 returns the status of the current for the module in channel B. A 1 means the current is out of range or was out of

range. When the laser current is out of range, the laser switches off. Bit 6 of the QUESTIONable:POWer node summarizes this node.

The QUESTIONable:POWer:HCURRent Node

This node gives a summary of the laser current for the higher wavelength of a dual wavelength source. Bit 0 returns the status of the current for the higher wavelength of the module in channel A. Bit 1 returns the status of the current for the higher wavelength of the module in channel B. A 1 means that the laser current is out of range or was out of range. When the laser current is out of range, the laser switches off. Bit 7 of the QUESTIONable:POWer node summarizes this node.

The QUESTIONable:POWer:LMONitor Node

This node gives a summary of the laser monitor current. For a dual wavelength source, this is the monitor current for the lower wavelength laser. Bit 0 returns the status of the monitor current for the module in channel A. Bit 1 returns the status of the monitor current for the module in channel B. A 1 means that the laser monitor current is currently out of range or was out of range. This node is summarized bit 8 of the QUESTIONable:POWer node.

The QUESTIONable:POWer:HMONitor Node

This node gives a summary of the laser monitor current for the higher wavelength of a dual wavelength source. Bit 0 returns the status of the monitor current for the higher wavelength of the module in channel A. Bit 1 returns the status of the monitor current for the higher wavelength of the module in channel B. A 1 means that the laser monitor current is currently out of range or was out of range. When the laser monitor current is out of range, the laser switches off. Bit 9 of the QUESTIONable:POWer node summarizes this node.

The QUESTIONable:POWer:ENVTemp Node

This node gives a summary of the laser environmental temperature. Bit 0 returns the status of the environmental temperature of the module in channel A. Bit 1 returns the status of the environmental temperature of the module in channel B. A 1 means that the laser environmental temperature is currently out of range or was out of range. When the laser environmental temperature is out of range, the laser switches off. Bit 10 of the QUESTIONable:POWer node summarizes this node.

Table 7-3. STATUS Command Summary

Command	Parameter
5> STATUS	
4> :SOURce	
3> :CONDition?	
3> :ENABle	
3> :ENABle?	<value>
3> [:EVENT]?	
3> :NTRansition	<value>
3> :NTRansition?	
3> :PTRansition	<value>

The SOURce node

Refer to “The Status Commands” as well as this section, to build a full description of the commands and queries that are available.

Note Unused bits in any of the registers return 0 when you read them.



The SOURce node gives a summary of the operation of the sources. Bit 0 returns the status of the source for the module in channel A. Bit 1 returns the status of the source for the module in channel B. A 1 means that the source is on. Bit 0 of the Status byte summarizes this node.

7

HP-IB Commands

This chapter gives a list of the HP 8153A HP-IB commands.

The commands are grouped according to the modules to which they refer. A list of the extra commands for a module are supplied with that module. Install the relevant pages into this chapter each time you add a module to your system.

ABORt Commands

This is one of the commands that relates to the triggering of sensor modules.

Table 8-1. ABORt Command Summary

<u>Command</u>	<u>Parameter</u>
ABORt	[1 2]

Specifying the Channel

You specify the channel by attaching a numeric suffix to the mnemonic. You access channel A by using ABORt1, you access channel B by using ABORt2. If do not add a suffix to the mnemonic, channel A is assumed.

ABORt

Syntax	ABORt[1 2]
Description	This command aborts the measurement being made.
Related Commands	INIT:IMM, INIT:CONT, INIT:CONT?
Example	OUTPUT 722;"ABOR"

DISPlay Commands

Any function that is related to the instrument display is included with the mainframe display commands.

Table 8-2. DISPlay Command Summary

Command	Parameter	Note
DISPlay		
:BRIGhtness	<value>	w/o unit
:BRIGhtness?		
[:STATe]	<boolean>	
[:STATe]?		

DISPlay:BRIGhtness

Syntax	DISPlay:BRIGhtness <wsp><value> $0 \leq \text{value} \leq 1$
Description	This command sets the brightness of the display. The brightness is a floating point number (Nrf) that can be set within the range 0 (lowest intensity) to 1 (full intensity). The default (for example, after a *RST command) is for the brightness to be set to 1. There are seven possible levels of intensity. So the value input for the brightness is rounded to the closest of seven values.
Related Commands	DISP:BRIG?, DISP:STAT, DISP:STAT?
Example	OUTPUT 722;"DISP:BRIG 0.5"

8

DISPlay:BRIGhtness?

Syntax	DISPlay:BRIGhtness?
Response	<value> $0 \leq \text{value} \leq 1$

Description	This command returns the brightness of the display. The brightness can be within the range 0 to 1. Where 0 means that the display is at it's lowest intensity, and 1 that it is full intensity.
Related Commands	DISP:BRIG, DISP:STAT, DISP:STAT?
Example	OUTPUT 722;"DISP:BRIG?" ENTER 722;A\$

DISPlay:STATe

Syntax	DISPlay[:STATe] <wsp><boolean>
Description	This command switches the display on or off. DISP:STAT ON switches the display on. DISP:STAT OFF switches the display off. The default (for example, after a *RST command) is for the display to be on.
Related Commands	DISP:BRIG, DISP:BRIG?, DISP:STAT?
Example	OUTPUT 722;"DISP:STAT ON"

DISPlay:STATe?

Syntax	DISPlay[:STATe]?
Response	<boolean>
Description	This command returns the state of the display. 0 means that the display is off. 1 means that the display is on.
Related Commands	DISP:BRIG, DISP:BRIG?, DISP:STAT
Example	OUTPUT 722;"DISP:STAT?" ENTER 722;A\$

FETCh Commands

This command relates to measuring signals with the sensor modules.

Table 8-3. FETCh Command Summary

<u>Command</u>	<u>Parameter</u>
FETCh[1 2]	[:SCALar]
	:POWER
	[:DC]?

Specifying the Channel

You specify the channel by attaching a numeric suffix to the FETCh mnemonic. You access channel A by using FETCh1, you access channel B by using FETCh2. If you do not add a suffix to the mnemonic, channel A is assumed.

FETCh[:SCALar]:POWER[:DC]

Syntax	FETCh[1 2][:SCALar]:POWER[:DC]?
Response	<value>
Description	<p>This command gets a reading from the module. It does not provide it's own triggering and so must be used with either a continuous or a preceding immediate trigger. The value read back is a floating point number in exponential number (NR3). The units of the number read back depend on whether the absolute or relative measurement mode is being used, and which units have been selected. The possible units are Watts, dBm, or dB.</p> <p>For averaging times of 1 second or less, a new measurement is available at the end of the averaging time. This is drawn in Figure 8-1. A measurement is available at the first x if an immediate trigger is used. A measurement is available at each x when continuous triggering is used.</p>



Figure 8-1. Measurements with $T_{Average} \leq 1$ second

For averaging times of more than 1 second, the x value is given by the formula

$$x_{new} = x_{old} \left(1 - \frac{T_{sample}}{T_{avg}} \right) + Sample \left(\frac{T_{sample}}{T_{avg}} \right)$$

Where

- x_{new} is the new result,
- x_{old} is the previous result,
- Sample is the value read by the hardware,
- T_{avg} is the averaging time (as set by the user), and
- T_{sample} is the time taken, by the hardware, to make a reading.

When a continuous trigger is used for averaging times of more than 1 second, the first measurement is available at the end of the averaging time. The second measurement is available 1 second later, and a new measurement is available every second after that. Each of these new measurements is the average for the readings of the preceding period. This is shown in Figure 8-2, $T_{Average}$ is 5s. First measurement is available at x_1 , which is the average for readings in the period $T_{Average}$. The second measurement is available at x_2 , and so on.

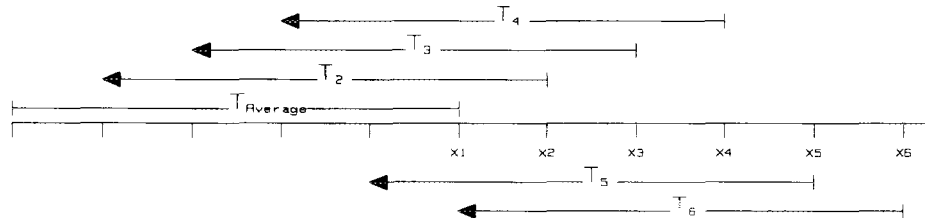

Figure 8-2. Measurements with $T_{Average} > 1$ second, continuous triggering.

When an immediate trigger is used for averaging times of more than 1 second, the first measurement is available at the end of the averaging time. The second measurement is available again at the end of the averaging time (once another trigger has been made), and so on. This is shown in Figure 8-3, $T_{Average}$ is 5s. First measurement is available at x_1 , which is the average for readings in the period T_1 . The second measurement is available at x_2 , which is the average for the readings in the period T_2 . Again in this case, the value is calculated by the formula

$$x_{new} = x_{old} \left(1 - \frac{T_{sample}}{T_{avg}} \right) + Sample \left(\frac{T_{sample}}{T_{avg}} \right)$$

Where

- x_{new} is the new result,
- x_{old} is the previous result,
- Sample is the value read by the hardware,
- T_{avg} is the averaging time (as set by the user), and
- T_{sample} is the time taken, by the hardware, to make a reading.



Figure 8-3.
Measurements with $T_{Average} > 1$ second, immediate triggering.

Related Commands READ:SCAL:POW:DC?, SENS:POW:REF:STAT,
 SENS:POW:REF:STAT? SENS:POW:UNIT, SENS:POW:UNIT?,
 INIT:IMM, INIT:CONT, INIT:CONT?

Example OUTPUT 722; "FETC:POW?"
 ENTER 722; A\$

INITiate Commands

This is one of the commands that relates to the triggering of sensor modules.

Table 8-4. INITiate Command Summary

<u>Command</u>	<u>Parameter</u>
INITiate[1 2]	
:CONTinuous	<boolean>
:CONTinuous?	
[:IMMEDIATE]	

Specifying the Channel

You specify the channel by attaching a numeric suffix to the mnemonic. You access channel A by using INITiate1, you access channel B by using or INITiate2. If do not add a suffix to the mnemonic, channel A is assumed.

INITiate:CONTinuous

Syntax	INITiate[1 2]:CONTinuous'' <wsp><boolean>
Description	This command initiates the trigger system for continuous trigger operation, that is, measurements are made continuously.
Related Commands	ABOR, INIT:IMM, INIT:CONT?
Example	OUTPUT 722;"INIT1:CONT OFF"

INITiate:CONTinuous?

Syntax	INITiate[1 2]:CONTinuous?''
Response	<boolean>
Description	This command returns whether the triggering system is operating continuously or not. The status is returned as either 0 or 1. 0 means that continuous triggering is not selected. 1 means that continuous triggering is selected.
Related Commands	ABOR, INIT:IMM, INIT:CONT

Example OUTPUT 722;"INIT:CONT?"
 ENTER 722;A\$

INITiate[:IMMediate]

Syntax INITiate[1|2][:IMMediate]"

Description This command initiates the trigger system and completes one full trigger cycle, that is, one measurement is made.

Related Commands ABOR, INIT:CONT, INIT:CONT

Example OUTPUT 722;"INIT2"

READ Commands

These commands relate to measuring signals with the sensor modules.

Table 8-5. READ Command Summary

<u>Command</u>	<u>Parameter</u>
READ[1 2]	[:SCALar] :POWER [:DC]?

Specifying the Channel

You specify the channel by attaching a numeric suffix to the or READ mnemonic. You access channel A by using READ1, you access channel B by using READ2. If you do not add a suffix to the mnemonic, channel A is assumed.

8 READ[:SCALar]:POWER[:DC]

Syntax READ[1|2][:SCALar]:POWER[:DC]?

Response <value>

Description This command gets a reading from the module. This command provides it's own triggering and does not need a triggering command. The value read back is a floating

8-8 Remote Operation - Commands

point number in exponential number (NR3). The units of the number read back depend on whether the absolute or relative measurement mode is being used, and which units have been selected. The possible units are Watts, dBm, or dB.

Each new measurement is available at the end of the averaging time.

Related Commands FETC:SCAL:POW:DC?, INIT, INIT:CONT, INIT:CONT?,
SENS:POW:REF:STAT, SENS:POW:REF:STAT?
SENS:POW:UNIT, SENS:POW:UNIT?

Example OUTPUT 722;"READ:POW?"
ENTER 722;A\$

SENSE Commands

Sense commands include most of the functions for setting up and using the sensor modules.

Table 8-6. SENSE Command Summary

Command	Parameter	Note
SENSE[1 2]		
:CORRection		
:COLLect		
:ZERO		
:ZERO?		
[:LOSS		
[:INPut		
[:MAGNitude]]	<value>	cal factor
[:MAGNitude]]?		cal factor
:POWer		
:ATIME	<value>[<unit>]	
:ATIME?		
:RANGe		
:AUTO	<boolean>	
:AUTO?		
[:UPPER]	<value>[<unit>]	
[:UPPER]?		
:REFerence	TOA TOB TOREF 0 1 2, <value>[<unit>]	
:REFerence?	TOA TOB TOREF 0 1 2	
:DISPlay	TOA TOB TOREF 0 1 2	no query
:STATe	<boolean>	
:STATe?		
:RATIo	TOA TOB TOREF 0 1 2	
:RATIo?		
:UNIT	<unit>	
:UNIT?		
:WAVElength	<value>[<unit>]	
:WAVElength?		

8

Specifying the Channel

You specify the channel by attaching a numeric suffix to the **SENSe** mnemonic. You access channel A by using **SENSe1**, and channel B by using **SENSe2**. If you do not add a suffix to the mnemonic, channel A is assumed.

SENSe:CORRection:COLLect:ZERO

Syntax **SENSe[1|2]:CORRection:COLLect:ZERO''**
Description This command zeros the electrical offsets for the module.
Related Commands **SENS:CORR:COLL:ZERO?**
Example **OUTPUT 722;"SENS2:CORR:COLL:ZERO"**

SENSe:CORRection:COLLect:ZERO?

Syntax **SENSe[1|2]:CORRection:COLLect:ZERO?''**
Response <value>
Description This command returns the status of the most recent zero command. 0 means that the zero succeeded without errors. 1 means that no remote zeroing operation has been performed. Any other value means that the remote zeroing failed, the value is the error code returned from the zero operation. The error codes are listed in Appendix I.
Related Commands **SENS:CORR:COLL:ZERO**
Example **OUTPUT 722;"SENS2:CORR:COLL:ZERO?"**
 ENTER 722;A\$

SENSe:CORRection[:LOSS[:INPut[:MAGNitude]]]

Syntax **SENSe[1|2]:CORRection''[:LOSS[:INPut[:MAGNitude]]]**
 <wsp><value>[<unit>]
 -200dB ≤ value ≤ +200dB
 unit is DB

8

Related Commands SENS:POW:RANG:UPPER, SENS:POW:RANG:UPPER?,
 SENS:POW:RANG:AUTO

Example OUTPUT 722;"SENS2:POW:RANG:AUTO?"
 ENTER 722;A\$

SENSe:POWer:RANGe[:UPPER]

Syntax SENSE[1|2]:POWER:RANGe[:UPPER]'
 <wsp><value>[<unit>]

 -110dBm < value < +30dBm. The actual limits depend on
 the module you use, please refer to the specifications for
 you module in Appendix C.

 unit is DBM

Description This command sets the power range for this module, that
 is the full-scale value for the display. The range changes
 at 10dBm intervals. The corresponding ranges for linear
 measurements (measurements in Watts) are given in the
 table below:



Table 8-7.

Range	Upper Linear Power Limit
+30dBm	1999.9mW
+20dBm	199.99mW
+10dBm	19.999mW
0dBm	1999.9 μ W
-10dBm	199.99 μ W
-20dBm	19.999 μ W
-30dBm	1999.9nW
-40dBm	199.99nW
-50dBm	19.999nW
-60dBm	1999.9pW
-70dBm	199.99pW
-80dBm	19.999pW
-90dBm	1.999pW
-100dBm	0.199pW
-110dBm	0.019pW

You specify the range as a floating point number (NRf). This number is rounded to the closest multiple of ten, because the range changes at 10dBm intervals. The units (dBm) can be included in the command. dBm are the units used if you do not specify units.

Related Commands SENS:POW:RANG:UPPER?, SENS:POW:RANG:AUTO, SENS:POW:RANG:AUTO?

Example OUTPUT 722;"SENS1:POW:RANG:UPPER -20DBM"

SENSe:POWer:RANGe[:UPPER]?

Syntax	SENSe[1 2]:POWer:RANGe[:UPPER]?"
Response	<value> $-110\text{dBm} \leq \text{value} \leq +30\text{dBm}$
Description	This command returns the range setting for the module. The range is returned as a signed integer (NR1). The returned value is in dBm. No units are returned in the response message.
Related Commands	SENS:POW:RANG:UPPER, SENS:POW:RANG:AUTO, SENS:POW:RANG:AUTO?
Example	OUTPUT 722;"SENS1:POW:RANG:UPPER?" ENTER 722;A\$

SENSe:POWer:REFerence

Syntax	SENSe[1 2]:POWer:REFerence" <wsp>TOA TOB TOREF 0 1 2,<value>[<unit>] $0.001\text{pW} \leq \text{value} \leq +9999.9\text{mW}$ $-200\text{dBm} \leq \text{value} \leq +200\text{dBm}$ with TOREF or 2 unit is PW NW UW MW Watt DBM $-200\text{dB} \leq \text{value} \leq +200\text{dB}$ with TOA or TOB or 0 or 1 unit is DB
Description	This command sets the reference level for this module. There are two types of reference. One is where the power being read by the module is expressed relative to this absolute level: $\text{Result}(\text{dB}) = \text{Measured}(\text{dBm}) - \text{Reference}(\text{dBm})$ Where the Measured value includes any calibration factor. You select this by using TOREF (or 2) and the value for the reference as a floating point number (NRf), with the

units dBm or Watts. dBm are the units used if you do not specify units.

The other type of reference is possible if you are using two power sensors, one in each channel. Here the quotient of the power readings for the two channels is expressed relative to the reference level:

$$Result(dB) = \frac{FirstChannelMeasured}{SecondChannelMeasured}(dB) - Reference(dB)$$

Where the Measured value includes any calibration factor.

You select this by using TOA (or 0) or TOB (or 1). You can only use TOB (or 1) for channel A when there are two sensor modules. You can only use TOA (or 0) for channel B when there are two sensor modules. You enter the value for the reference as a floating point number (NRf). You can include the units (dB) in the command. dB are the units used if you do not specify units.

Related Commands SENS:POW:REF?, SENS:POW:REF:STATE,
SENS:POW:REF:STATE?, SENS:POW:REF:STATE:RATI,
SENS:POW:REF:STAT:RATI?, SENS:POW:REF:DISP

Example OUTPUT 722; "SENS:POW:REF TOREF, 10DBM"

SENSe:POWer:REFerence?

Syntax SENSe[1|2]:POWer:REFerence?"
<wsp>TOA|TOB|TOREF|0|1|2

Response <value>
 $0.001\text{pW} \leq \text{value} \leq +9999.9\text{mW}$
 $-200\text{dBm} \leq \text{value} \leq +200\text{dBm}$
with TOREFor 2

 $-200\text{dB} \leq \text{value} \leq +200\text{dB}$
with TOB (or 1) or TOA (or 0)

Description This command returns the reference level that is set for the module. There are three possible references, you

select the reference you want by using one of TOA (or 0), TOB (or 1) or TOREF (or 2). The reference is returned as a floating point number in exponential number (NR3). The returned value is in the selected absolute units (Watts or dBm), if you specified TOREF (or 2), or in dB, if you specified TOB (or 1) or TOA (or 0). No units are returned in the response message.

Related Commands SENS:POW:REF, SENS:POW:REF:STATE,
 SENS:POW:REF:STATE?, SENS:POW:REF:STATE:RATI,
 SENS:POW:REF:STAT:RATI?, SENS:POW:REF:DISP,
 SENS:POW:UNIT, SENS:POW:UNIT?

Example OUTPUT 722;"SENS1:POW:REF? TOA"
 ENTER 722;A\$

SENSe:POWer:REFerence:DISPlay

Syntax SENSE[1|2]:POWer:REFerence:DISPlay"

Description This command sets the reference level for this module from the input power-level. There are two types of reference. One is where the power being read by the module is expressed relative to this absolute level:

$$Result(dB) = Measured(dBm) - Reference(dBm)$$

Where the Measured value includes any calibration factor.

You select this by using TOREF with the SENSE:POWer:REFerence command.

The other type of reference is possible if you are using two power sensors, one in each channel. Here the quotient of the power readings for the two channels is expressed relative to the reference level:

$$Result(dB) = \frac{FirstChannelMeasured}{SecondChannelMeasured}(dB) - Reference(dB)$$

Where the Measured value includes any calibration factor.

You select this by using TOB or TOA with the SENSE:POWer:REFerence command.

Related Commands `SENS:POW:REF`, `SENS:POW:REF?`, `SENS:POW:REF:STATE`,
`SENS:POW:REF:STATE?`, `SENS:POW:REF:STAT:RATI`,
`SENS:POW:REF:STAT:RATI?`

Example `OUTPUT 722;"SENS:POW:REF TOREF"`
`OUTPUT 722;"SENS:POW:REF:DISP"`

SENSe:POWer:REFerence:STATe

Syntax `SENSe[1|2]:POWer:REFerence:STATe'' <wsp><boolean>`

Description This command sets whether the results are in relative or absolute units. The reference state is specified by a boolean. `OFF`, or `0`, means that the result is absolute (that is, in dBm or Watts). `ON`, or any non-zero value, means that the result is relative to a reference level (that is, in dB).

Related Commands `SENS:POW:REF`, `SENS:POW:REF?`, `SENS:POW:REF:STATE?`,
`SENS:POW:REF:STATE:RATI`, `SENS:POW:REF:STAT:RATI?`,
`SENS:POW:REF:DISP`, `SENS:POW:UNIT`, `SENS:POW:UNIT?`

Example `OUTPUT 722;"SENS1:POW:REF:STATE ON"`

SENSe:POWer:REFerence:STATe?

Syntax `SENSe[1|2]:POWer:REFerence:STATe?''`

Response `<boolean>`

Description This command returns whether the results are in relative or absolute units. The ranging is returned as either `0` or `1`. `0` means that the results are absolute (that is, in dBm or Watts). `1` means that the result is relative to a reference (that is, in dB).

Related Commands `SENS:POW:REF`, `SENS:POW:REF?`, `SENS:POW:REF:STATE`,
`SENS:POW:REF:STATE:RATI`, `SENS:POW:REF:STAT:RATI?`,
`SENS:POW:REF:DISP`, `SENS:POW:UNIT`, `SENS:POW:UNIT?`

Example `OUTPUT 722;"SENS1:POW:REF:STAT?"`
`ENTER 722;A$`

SENSe:POWer:REFeRence:STATe:RATIo

Syntax	SENSe[1 2]:POWer:REFeRence:STATe:RATIo" <wsp>TOA TOB TOREF 0 1 2
Description	This command selects the reference with respect to which the results for this module are given. That is whether the results are displayed relative to channel A TOA (or 0), relative to channel B TOB (or 1), or relative to an absolute reference TOREF (or 2). TOB (or 1) is only possible for channel A of an instrument that has a sensor in each channel. TOA (or 0) is only possible for channel B of an instrument that has a sensor in each channel.
Related Commands	SENS:POW:REF, SENS:POW:REF?, SENS:POW:REF:STATE, SENS:POW:REF:STATE?, SENS:POW:REF:STAT:RATI?, SENS:POW:REF:DISP
Example	OUTPUT 722;"SENS2:POW:REF:STAT:RATI TOB"

SENSe:POWer:REFeRence:STATe:RATIo?

Syntax	SENSe[1 2]:POWer:REFeRence:STATe:RATIo?"
Response	0 1 2
Description	This command returns the reference setting for the module. The ranging is returned as one of 0, 1, or 2. 0 is returned if channel A is being used as a reference for channel B. 1 is returned if channel B is being used as a reference for channel A. 2 is returned if an absolute reference is being used.
Related Commands	SENS:POW:REF, SENS:POW:REF?, SENS:POW:REF:STATE, SENS:POW:REF:STATE?, SENS:POW:REF:STAT:RATI, SENS:POW:REF:DISP
Example	OUTPUT 722;"SENS1:POW:REF:STAT:RATI?" ENTER 722;A\$

8

SENSe:POWer:UNIT

Syntax	<code>SENSe[1 2]:POWer:UNIT'' <wsp><unit></code> unit is DBM Watt 0 1
Description	This command sets the units in use when an absolute reading is made. This can be dBm (DBM 0) or Watts (Watt 1).
Related Commands	<code>SENS:POW:UNIT?</code> , <code>SENS:POW:REF:STATE</code> , <code>SENS:POW:REF:STATE?</code>
Example	<code>OUTPUT 722;"SENS1:POW:UNIT W"</code>

SENSe:POWer:UNIT?

Syntax	<code>SENSe[1 2]:POWer:UNIT?''</code>
Response	<code><unit></code>
Description	This command returns the units selected for absolute readings. 0 means that dBm is being used as the absolute units. 1 means that Watts are being used as the absolute units.
Related Commands	<code>SENS:POW:UNIT</code> , <code>SENS:POW:REF:STATE</code> , <code>SENS:POW:REF:STATE?</code>
Example	<code>OUTPUT 722;"SENS2:POW:UNIT?"</code> <code>ENTER 722;A\$</code>

SENSe:POWer:WAVElength

Syntax	<code>SENSe[1 2]:POWer:WAVElength'' <wsp><value>[<unit>]</code> $450\text{nm} \leq \text{value} \leq 1700\text{nm}$. The actual limits depend on the module you use, please refer to the specifications for you module in Appendix C. unit is NM UM M
Description	This command sets the wavelength for this module. You specify the wavelength as a floating point number (NRf). The units can be nanometers, micrometers or meters. Meters are the units used if you do not specify units.

Related Commands SENS:POW:WAVE?
 Example OUTPUT 722;"SENS2:POW:WAVE 1300NM"

SENSe:POWer:WAVElength?

Syntax SENSE[1|2]:POWer:WAVElength?"
 Response <value>
 450nm ≤ value ≤ 1020nm
 Description This command returns the wavelength setting for the module. The result is returned as a floating point number in exponential number (NR3). The returned value is in meters. No units are returned in the response message.
 Related Commands SENS:POW:WAVE
 Example OUTPUT 722;"SENS2:POW:WAVE?"
 ENTER 722;A\$

SOURce Commands

Any function that is related to source modules is included with the source commands.

Table 8-8. SOURce Command Summary

Command	Parameter
SOURce[1 2]	
:AM	
[:INTernal]	
:FREQuency	<value>[<unit>] CW
:FREQuency?	
:POWer	
:ATTenuation[1 2]	<value>[<unit>]
:ATTenuation[1 2]?	
:STATe	<boolean>
:STATe?	
:WAVElength	UPPER LOWer BOTH
:WAVElength?	

Specifying the Channel

You specify the channel by attaching a numeric suffix to the **SOURCE** mnemonic. You access channel A by using **SOURCE1**, or channel B by using **SOURCE2**. If you do not add a suffix to the mnemonic, channel A is assumed.

SOURCE:AM[:INTERNAL]:FREQUENCY

Syntax	<code>SOURCE[1 2]:AM[:INTERNAL]:FREQUENCY''</code> <code><wsp><value>[<unit>] CW</code> <code>value = 0Hz 270Hz 1kHz 2kHz</code> <code>unit is HZ KHZ</code>
Description	This command sets the frequency of the amplitude modulation of the source output signal. You specify the frequency as a floating point number (NRf). Units can be attached, one of Hz, or kHz can be specified. Hertz are the units used if you do not specify units. CW results in a continuous wave being output, this is equivalent to specifying 0Hz.
Related Commands	<code>SOUR:AM[:INTERNAL]:FREQ?</code>
Example	<code>OUTPUT 722;"SOUR:AM[:INTERNAL]:FREQ 10KHZ"</code>

SOURCE:AM[:INTERNAL]:FREQUENCY?

Syntax	<code>SOURCE[1 2]:AM[:INTERNAL]:FREQUENCY?''</code>
Response	<code><value></code> <code>value = 0Hz 270Hz 1kHz 2kHz</code>
Description	This command returns the setting for the frequency of modulation of the output of the source module. The frequency is returned as a number in exponential format. The returned value is in Hertz. A returned value of 0Hz means that continuous wave is selected. No units are returned in the response message.
Related Commands	<code>SOUR:AM[:INTERNAL]:FREQ</code>
Example	<code>OUTPUT 722;"SOURCE2:AM[:INTERNAL]:FREQ?"</code> <code>ENTER 722;A\$</code>

SOURce:POWer:ATTenuation

Syntax	<code>SOURce[1 2]:POWer:ATTenuation"[1 2] <wsp><value>[<unit>] 0 ≤ value ≤ 6.0 unit is DB</code>
Description	This command sets the attenuation of the source output signal. You specify the attenuation as a floating point number. Units can be attached. dB are the units used if you do not specify units. SOUR:POW:ATT2 is used with the higher wavelength of a dual wavelength source.
Related Commands	<code>SOUR:POW:ATT?</code>
Example	<code>OUTPUT 722;"SOUR:POW:ATT 1.0DB"</code>

SOURce:POWer:ATTenuation?

Syntax	<code>SOURce[1 2]:POWer:ATTenuation"[1 2]?</code>
Response	<code><value> 0 ≤ value ≤ 6.0</code>
Description	This command returns the setting for the attenuation of the output of the source module. The attenuation is returned as a number in exponential format. The returned value is in dB. No units are returned in the response message.
Related Commands	<code>SOUR:POW:ATT</code>
Example	<code>OUTPUT 722;"SOURc2:POW:ATT1?" ENTER 722;A\$</code>

8

SOURce:POWer:STATE

Syntax	<code>SOURce[1 2]:POWer:STATE" <wsp><boolean></code>
Description	This command sets the state of the source output signal. You specify the state as a boolean. OFF, or 0, disables the source. ON, or any non-zero number, enables the source.
Related Commands	<code>SOUR:POW:STAT?</code>

Example OUTPUT 722;"SOUR:POW:STAT OFF"

SOURce:POWer:STATe?

Syntax SOURce[1|2]:POWer:STATe?"

Response <boolean>

Description This command returns the current setting for the state of the source. 0 means that the source is disabled. 1 means that the source is enabled.

Related Commands SOUR:POW:STAT

Example OUTPUT 722;"SOURc2:POW:STAT?"
ENTER 722;A\$

SOURce:POWer:WAVElength

Note This command only works with dual wavelength sources.



Syntax SOURce[1|2]:POWer:WAVElength"
<wsp>UPPer|LOWer|BOTH

Description This command sets the wavelength of the output signal. You specify the choice as UPPer for the longer of the two wavelengths, LOWer for the shorter of the two wavelengths, or BOTH if the two wavelengths are to be enabled together.

Related Commands SOUR:POW:WAVE?

Example OUTPUT 722;"SOUR:POW:WAVE UPP"

SOURce:POWer:WAVElength?

Syntax	SOURce[1 2]:POWer:WAVElength?"
Response	<value> The value is the actual wavelength of the source. This depends on the module being used.
Description	This command returns the setting for the wavelength of the output of the source module. The frequency is returned as a number in exponential format. The returned value is in meters. No units are returned in the response message. When both wavelengths of a dual wavelength source have been enabled, the query returns 0
Related Commands	SOUR:POW:WAVE
Example	OUTPUT 722;"SOUR2:POW:WAVE?" ENTER 722;A\$

SYSTEM Commands

Any function that is not specifically related to instrument performance is included with the mainframe system commands.

Table 8-9. SYSTEM Command Summary

Command	Parameter	Note
SYSTEM		
:DATE	<year> , <month> , <day>	2 char. each/4 char. for year
:DATE?		
:ERRor?		Query only
:TIME	<hour> , <minute> , <second>	2 char. each
:TIME?		

SYSTem:DATE

Syntax	<code>SYSTem:DATE <wsp><year>,<month>,<day></code> $1990 \leq \text{year} \leq 2089$ $1 \leq \text{month} \leq 12$ $1 \leq \text{day} \leq 31$
Description	This command sets the date on the internal clock in the instrument. You enter the date as three integers separated by commas. The date is not affected by normal reset conditions (*RST, power-off, and so on).
Related Commands	<code>SYST:DATE?</code> , <code>SYST:TIME</code> , <code>SYST:TIME?</code>
Example	<code>OUTPUT 722;"SYST:DATE 1990,1,17"</code>

SYSTem:DATE?

Syntax	<code>SYSTem:DATE?</code>
Response	<code><year> <month> <day></code> $1990 \leq \text{year} \leq 2089$ $1 \leq \text{month} \leq 12$ $1 \leq \text{day} \leq 31$
Description	This command returns the date from the internal clock in the instrument. The date is returned as three integers (NR1).
Related Commands	<code>SYST:DATE</code> , <code>SYST:TIME</code> , <code>SYST:TIME?</code>
Example	<code>OUTPUT 722;"SYST:DATE?"</code> <code>ENTER 722;A\$</code>

SYSTem:ERRor?

Syntax	<code>SYSTem:ERRor?</code>
Response	<code><value> <string></code> $-32768 \leq \text{value} \leq +32767$ For the HP 8153A the string is always empty ("").

Description This command returns an error code. The error queue is organized as a First-In, First-Out (FIFO) queue. This means that it is always the oldest error in the queue that is returned. Only one error is returned per query.

A list of the errors and the error codes is given in Appendix I.

A returned error code of 0 means that there are no errors.

Example OUTPUT 722;"SYST:ERR?"
ENTER 722; A\$

SYSTem:TIME

Syntax SYSTem:TIME <wsp><hour>,<minute>,<second>

$0 \leq \text{hour} \leq 23$
 $0 \leq \text{minute} \leq 59$
 $0 \leq \text{second} \leq 60$

Description This command sets the time on the internal clock in the instrument. You enter the time as three integers, separated by commas. Note that the seconds can be set to a value in the range 0 to 60. When you set the seconds to 60, the actual value for the seconds is zero but the minutes are incremented. The hours, day, month and year may also be incremented. For example, if you set the time by the command SYST:TIME 23,59,60 the time is set to midnight and the day is incremented. The time is set to the new value immediately when the message has been parsed.

The time is not affected by reset conditions (*RST, power-off, and so on).

Related Commands SYST:DATE, SYST:DATE, SYST:TIME?

Example OUTPUT 722;"SYST:TIME 9,15,0"

8

SYSTem:TIME?

Syntax SYSTem:TIME?
Response <hour> <minute> <second>
 $0 \leq \text{hour} \leq 23$
 $0 \leq \text{minute} \leq 59$
 $0 \leq \text{second} \leq 59$

Description This command returns the time from the internal clock in the instrument. The time is returned as three integers (NR1).

Related Commands SYST:DATE, SYST:DATE?, SYST:TIME

Example OUTPUT 722;"SYST:TIME?"
ENTER 722;A\$



HP-IB Application Commands

This chapter gives a list of the HP 8153A HP-IB commands for running applications remotely.

The commands are grouped according to the modules to which they refer. A list of the commands for a module are supplied with that module. Install the relevant pages into this chapter each time you add a module to your system.

Program Commands

All the applications are run using the PROGram commands.

The applications do not automatically enable local lockout. It is possible for someone to disturb an application that is under remote control by using the front panel keys. To avoid this, you can activate the local lockout.

It is possible to disturb an application by sending programming commands to the channel in which the application is running. Use the status commands to check that the application has finished before sending any more commands to the channel.

Table 9-1. PROGram Command Summary

Command	Parameter	Note
PROGram[1 2]		
:[:SELEcted]		
:EXECute		
:NAME	<application>	
:NAME?		
:NUMBer	<varname>,<value>	
:NUMBer?	<varname>	
:STATe	CONTInue PAUSE RUN STOP 0 1 2 3	
:STATe?		

You specify the channel by attaching a numeric suffix to the PROGram mnemonic. You access channel A by using PROGram1, and channel B by using PROGram2. If you do not add a suffix to the mnemonic, channel A is assumed.

PROGram[:SELEcted]:EXECute

Syntax PROGram[1|2]:[:SELEcted]:EXECute"
 Description This command runs the selected application.
 Related Commands PROG:SEL:NAME
 Example OUTPUT 722;"PROG:SEL:EXEC"

PROGram[:SELEcted]:NAME

Syntax PROGram[1|2]:[:SELEcted]:NAME" <wsp><application>
 The possible values for application depend on the modules installed. For the mainframe:
 Description This command selects an application. All further PROGram commands apply only to the selected application.
 The default (for example, after a *RST) is for PROG to be selected. PROG is not an application and cannot be run.
 Related Commands PROG:SEL:NAME?
 Example OUTPUT 722;"PROG:SEL:NAME LOGGING"

9-2 Remote Operation - Application Commands

PROGram[:SElected]:NAME?

Syntax	PROGram[1 2][:SElected]:NAME?"
Response	<application>
Description	This command returns the name of the selected application. If no application has been selected, NO APPL is returned.
Related Commands	PROG:SEL:NAME
Example	OUTPUT 722;"PROG:SEL:NAME?" ENTER 722;A\$

PROGram[:SElected]:NUMBER

Syntax	PROGram[1 2][:SElected]:NUMBER" <wsp><varname>,<value>
Description	The possible values for varname and value depend on the selected application. This command sets the parameters for an application. The parameters that you can use with this command depend on the selected application.
Related Commands	PROG:SEL:NUMBER?, PROG:SEL:NAME
Example	OUTPUT 722;"PROG:SEL:NUMBER SAMPLES,100"

PROGram[:SElected]:NUMBER?

Syntax	PROGram[1 2][:SElected]:NUMBER?" <wsp><varname>
Response	<value> The values returned depend on the selected application.
Description	This command returns the results from the application most recently run by the PROGram[:SElected]:EXECute command. It cannot be used to read out results immediately after a power up (that is, before an application has been run), or to read the results of an application run under local control.
Related Commands	PROG:SEL:NUMB, PROG:SEL:NAME

Example OUTPUT 722;"PROG:SEL:NUMB? ASAMPLES"
 ENTER 722;A\$

PROGram[:SElected]:STATE

Syntax PROGram[1|2][:SElected]:STATE"
 CONTInue|PAUSE|RUN|STOP|0|1|2|3

Description This command sets the state for an application. RUN (or 2) runs the application, this is equivalent to PROG:SEL:EXEC. PAUSE (or 1) pauses the application. STOP (or 3) stops the application. CONTInue (or 0) restarts the application after a PAUSE.

Related Commands PROG:SEL:STATe?, PROG:SEL:NAME

Example OUTPUT 722;"PROG:SEL:STATe RUN"

PROGram[:SElected]:STATe?

Syntax PROGram[1|2][:SElected]:STATe?"

Response 0|1|2|3

Description This command returns state of the selected application. 0 means that the application is continuing (after a pause). 1 means that the application is paused. 2 means that an application is running. 3 means that an application is stoppe.

Related Commands PROG:SEL:STAT, PROG:SEL:NAME

Example OUTPUT 722;"PROG:SEL:STAT?"
 ENTER 722;A\$

Mainframe Applications

These are applications that are supplied with the software of the mainframe. For more complete explanation of the application, refer to Chapter 3

The Logging Application

application LOGGING

Note



This application only runs on an instrument with a sensor module.

Parameters

- varname = SAMPLES, this is the number of samples to be taken.

$$1 \leq \text{value} \leq 500$$

The total time for the logging application consists of the averaging time and the time to process the sample. That is, a sample is only taken after the previous sample has been taken and processed.

The processing time depends on a number of factors including the system configuration. If any applications or measurements are running in the other channel, the processing time between samples may vary.

On printer or plotter outputs, the total time given for the logging application includes both the averaging and the processing time.

- varname = LOGGSTART, this is the starting condition.

value = 1|2|3 where

- 1 means start when the input power-level is above threshold.
- 2 means start when the input power-level is below threshold.
- 3 means start immediately.

- varname = THRESHOLD, this is the threshold level for starting. It is only applicable when LOGGSTART is set to 1 or 2.

Note

Do not specify units for this parameter



$$-400 \leq \text{value} \leq 400$$

The value for the threshold level is in dBm.

The other parameters (such as T_{avg} and wavelength) must be set with a SENSE command.

Results

- varname = ASAMPLES, the number of samples taken.
- varname = RESULT, the logged values. This is returned as a string of values separated by commas (,), or as an array of values, depending on the controlling program.

The Stability Application

application

STABILITY

Note

This application only runs on an instrument with a sensor module.

**Parameters**

- varname = T_TOTAL, this is the total time for which the application is to be run. The difference of the actual total time from T_TOTAL depends on a number of factors including the system configuration. The worst case timing difference is 30s/h.

$$0 \leq \text{value} \leq 359,999$$

value is the total time in seconds.

The other parameters (such as T_{avg} and wavelength) must be set with a SENSE command.

Results

9-6 Remote Operation - Application Commands

- varname = ASAMPLES, the number of samples taken.
- varname = RESULT, the stability values. This is returned as a string of values separated by commas (,), or as an array of values, depending on the controlling program.



HP-IB Programming Examples

This chapter gives some programming examples. The language used for programming is BASIC 4.0 Language System used on HP 9000 Series 200/300 computers.

These programming examples do not cover the full command set for the instrument. They are intended only as an introduction to the method of programming the instrument and the principles behind TMSL.

Example 1

Function

This program displays the time from the real time clock on the HP 8153A.

Listing

```
10 ON KBD GOTO Exit
20 INTEGER Hour, Min, Sec
30 Pmm=722
40 GINIT
50 CSIZE 14
60 GRAPHICS ON
65 !
70 LOOP
80   OUTPUT Pmm;"syst:time?"
90   ENTER Pmm; Hour, Min, Sec
100  GCLEAR
110  MOVE 30,50
120  LABEL USING "ZZ,A,ZZ,A,ZZ";Hour;":";Min;":";Sec
130  END LOOP
135  !
140 Exit: GRAPHICS OFF
150  END
```

Description

Line No.

10	Execution goes to Exit when a key on the keyboard is hit.
20	Declaration of variables.
30	Setting the address of the instrument (Address = 22).
40 to 60	Initializes the screen
70	Start of the main loop in the program.
80 to 90	Input the system time from the HP 8153A.
100 to 120	Display the time.
130	Loop to 70
140 to 150	Restore the screen and end the execution of the program.

10-2 Remote Operation - Programming Examples

Example 2

For this program to work, you need a sensor module in channel A.

Function

This program reads in values from the HP 8153A, and counts the number that are read twice in succession.

Listing

```

10  INTEGER Dcount
20  REAL Value1,Value2
30  Dcount=0
40  Value1=-1000
50  Pmm=722
60  CLEAR SCREEN
65  !
70  OUTPUT Pmm;"*sre 0;*ese 0"
80  OUTPUT Pmm;"*cls"
90  OUTPUT Pmm;"sens1:pow:unit w;rang:auto on"
95  !
100 LOOP
110  OUTPUT Pmm;"read1:pow?"
120  ENTER Pmm;Value2
130  IF Value2=Value1 THEN Dcount=Dcount+1
140  Value1=Value2
150  PRINT TABXY(10,10);"Measurement Value  : ";Value2
160  PRINT TABXY(10,11);"Double Read Values : ";Dcount
170  END LOOP
175  !
180  END

```

Description

Line No.

- | | |
|----------|--|
| 10 to 60 | Declarations and initializations. |
| 70 | Disable common status interrupts. |
| 80 | Clear the status |
| 90 | Set the sensor units to Watts and make sure that automatic ranging is in operation. Note the use of the semicolon so that we do not need to repeat the <code>sens1:pow</code> part of the command. |

Example 2

- 110 to 120 Take a reading from the sensor. The `read1:pow` instruction does not need a separate triggering command.
- 130 Check to see if the new reading is the same as the last one. If it is, increment the count of double readings.
- 140 Store the new reading for the next time round.
- 140 to 150 Display the current reading, and the number of double readings.

Example 3

For this program to work, you need a sensor module in channel A.

Function

This program reads in values from the HP 8153A, and counts the number that are read twice in succession. The difference between this and the program given in example 2, is that this program uses a command that needs a separate triggering command.

Listing

```
10 INTEGER Dcount, Vcount
20 REAL Value1, Value2
30 Dcount=0
40 Vcount=0
50 Value1=-1000
60 Pmm=722
70 CLEAR SCREEN
75 !
80 OUTPUT Pmm;"*sre 0;*ese 0"
90 OUTPUT Pmm;"*cls"
100 OUTPUT Pmm;"sens1:pow:unit w;rang:auto on"
110 OUTPUT Pmm;"init1:cont on"
115 !
120 LOOP
130   OUTPUT Pmm;"fetch1:pow?"
140   ENTER Pmm;Value2
150   IF Value2=Value1 THEN Dcount=Dcount+1
160   Value1=Value2
170   Vcount=Vcount+1
180   PRINT TABXY(10,10);"Measurement Value : ";Value2
190   PRINT TABXY(10,11);"Number Of Values : ";Vcount
200   PRINT TABXY(10,11);"Double Read Values : ";Dcount
210 END LOOP
215 !
220 END
```

Example 3**Description****Line No.**

10 to 70	Declarations and initializations.
80	Disable common status interrupts.
90	Clear the status.
100	Set the sensor units to Watts and make sure that automatic ranging is in operation.
110	Switch on continuous triggering.
130 to 140	Take a reading from the sensor using <code>fetch1:pow</code> . The triggering for this command is provided by the continuous trigger.
150 to 200	Check to see if the new reading is the same as the last one. If it is, increment the count of double readings. Store the new reading for the next time round. Display the current reading, the total number of readings, and the number of double readings.

Example 4

For this program to work, you need a sensor module in channel A or channel B.

Function

This program counts the number of times the power reading goes into overrange.

When this program is running, put the instrument under local operation (use **Local**), make sure that RMT is off). Set the range to the lowest manual range. Apply an optical signal to the sensor, and switch this signal on and off to generate an overload.

Listing

```

10 ASSIGN @Pmm TO 722
15 !
20 OUTPUT @Pmm;"*cls"
30 OUTPUT @Pmm;"stat:ques:pow:overr:ptr 3;ntr 0;enab 3"
40 OUTPUT @Pmm;"stat:ques:pow:ptr 1;ntr 0;enab 1"
50 OUTPUT @Pmm;"stat:ques:ptr 8;ntr 0;enab 8"
60 OUTPUT @Pmm;"*sre 8"
65 !
70 REPEAT
80   OUTPUT @Pmm;"syst:err?"
90   ENTER @Pmm;Err
100  IF Err<>0 THEN PRINT "Error Code = ";Err
110 UNTIL Err=0
115 !
120 CLEAR SCREEN
130 PRINT TABXY(20,10);"Waiting for HP-IB-Interrupt in an endless loop."
140 PRINT TABXY(20,11);"If an Overrange occurs, a counter will be"
150 PRINT TABXY(20,12);"incremented."
160 PRINT TABXY(20,14);"Overrange Count : ";
170 PRINT TABXY(20,15);"Serial Poll      : ";
175 !
180 ON INTR 7 GOSUB Pmm_srq
190 ENABLE INTR 7;2
195 !
200 Ende = 0
210 REPEAT
220 UNTIL Ende=200
225 !
230 GOTO 320
235 !

```

Example 4

```

240 Pmm_srq: Value=SPOLL(@Pmm)
250     Ende=Ende+1
260     PRINT TABXY(38,14);Ende
270     PRINT TABXY(38,15);Value
275     !
280     OUTPUT @Pmm;"*cls"
290     LOCAL @Pmm
300     ENABLE INTR 7
310     RETURN
315     !
320 END

```

Description**Line No.**

20	Clear the status
30	Set up the transition filters, and the enable register for the QUESTIONable:POWER:OVERRRange node. An overrange for channel A is signalled in bit 0 of this node, an overrange for channel B is signalled in bit 1. We enable both bits 0 and 1 for positive transitions, that is, if either of these two bits goes from 0 to 1 in the condition register, the corresponding bit is set in the event register. Negative transitions are ignored. The enable register is set for both bits 0 and 1, so that if either are set, they set the summary bit in the QUESTIONable:POWER node.
40	Set up the transition filters, and the enable register for the QUESTIONable:POWER node. Bit 0 is set up here, this is the summary bit for the QUESTIONable:POWER:OVERRRange node.
50	Set up the transition filters, and the enable register for the QUESTIONable node. Bit 3 is set up here, this is the summary bit for the QUESTIONable:POWER node.
60	Set up the Status Request Enable register. This causes an interrupt when the bit reflecting the QUESTIONable node is set.
70 to 100	Clear the error queue, by reading out all the error messages. This command makes sure that the initialisation commands (lines 30-60) have run.
120 to 170	Set up the display.
180 to 190	Set up the interrupt service routine and enable the interrupt.

Example 4

200 to 220	A loop for the program while waiting for the interrupt.
240 to 310	The interrupt service routine.
240	Perform a serial poll.
250	Increment the overrange count.
260 to 270	Display the results.
280	Make sure that the status is cleared.
290	Make sure that the instrument is in local operation.
300	Enable the interrupt again.

Example 5

```

330 GOTO 690
335 !
340 Pmm_srq: Value=SPOLL(@Pmm)
345 !
350 Ypos=3
355 !
360 FOR Z=0 TO 1
370 B=128
380 Xpos=7
385 !
390 REPEAT
400 Quot=Value DIV B
410 IF Quot>0 THEN
420 PRINT TABXY(Xpos,Ypos);"1"
430 Value=Value-B
435 !
440 IF Z=0 THEN
450 IF B=16 THEN
460 ENTER @Pmm;A$
470 PRINT TABXY(21,18);"
480 PRINT TABXY(21,18);A$
490 END IF
500 END IF
505 !
510 ELSE
520 PRINT TABXY(Xpos,Ypos);"0"
530 END IF
540 B=B DIV 2
550 Xpos=Xpos+4
560 UNTIL B=0
565 !
570 OUTPUT @Pmm;"*esr?"
580 ENTER @Pmm;Value
590 Ypos=12
595 !
600 NEXT Z
605 !
610 REPEAT
620 OUTPUT @Pmm;"syst:err?"
630 ENTER @Pmm;Value
640 IF VALUE<>0 THEN PRINT TABXY(21,17);Value
650 UNTIL Value=0
655 !
660 OUTPUT @Pmm;"*cls"
670 ENABLE INTR 7
680 RETURN
685 !
690 END

```

Example 5**Description****Line No.**

10 to 50	Declarations and Initializations.
60	Set up the status enable registers.
70 to 250	Set up the display.
260	Set up for the main program loop.
270	Enable the interrupt.
280 to 330	The main program loop, take in a command and send it to the instrument.
340 to 680	The interrupt service routine.
340	Make a serial poll to get the contents of the Status Byte.
390 to 560	Look at each bit of the register.
410 to 500	This part looks after a bit if it is set.
420 to 430	Display the set bit.
440 to 500	Check to see if it is the MAV bit, and if it is, get the contents of the output queue and display them.
520	Display the bit if it is not set.
530 to 550	Set up for the next bit.
570 to 590	Read the Standard Event Status register and set up to display its contents.
610 to 650	Read a value from the error queue and display it, until the queue is empty.
660 to 670	Clear the status and enable the interrupt again.

Example 6

Function

This program runs the stability application, and at the end outputs the results to the screen of the controller.

Listing

```

10 ON KBD GOTO Exit
20 ON INTR 7 GOSUB Pmm_srq
30 !
40 INTEGER Appl_ready,Asamples
50 INTEGER T_total
60 REAL F(499)
70 !
80 T_total=30
90 Pmm=722
100 !
110 OUTPUT Pmm;"*rst;*cls;*sre 128"
120 OUTPUT Pmm;"stat:pres"
130 OUTPUT Pmm;"stat:oper:enab #H4000"
140 OUTPUT Pmm;"sens1:pow:atime 1s;unit dbm"
150 OUTPUT Pmm;"prog1:name stability"
160 OUTPUT Pmm;"prog1:numb t_total,";T_total
170 !
180 Appl_ready=0
190 OUTPUT Pmm;"prog1:exec"
200 ENABLE INTR 7;2
210 !
220 REPEAT
230 UNTIL Appl_ready=1
240 !
250 BEEP
270 !
280 OUTPUT Pmm;"prog1:numb? asamples"
290 ENTER Pmm;Asamples
300 REDIM F(Asamples-1)
310 !
320 OUTPUT Pmm;"prog1:numb? result"
330 ENTER Pmm;F(*)
340 !
350 FOR I=0 TO Asamples-1
360     PRINT F(I)
370 NEXT I
380 !
390 WAIT 5.0

```

Example 6

```

400 GOTO Exit
410 !
420 Pmm_srq: Appl_ready=1
430         OUTPUT Pmm;"*cls"
440         ENABLE INTR 7
450         RETURN
460 !
470 Exit: END

```

Description**Line No.**

20	Sets up where the program goes on the receipt of an interrupt from the HP-IB.
110	Reset and clear the instrument, then enable the interrupt from the Master Summary Status bit.
120, 130	Enable the interrupt from the OPERATION:PROGRAM node.
140	Set the acquisition time and the units for the results.
150	Select the application.
160	Set the parameter.
190	Run the application.
200	Enable the interrupt.
220, 230	Put the program into a loop. The exit condition for this loop is fulfilled in the interrupt service subroutine.
280, 290	Read in the number of samples that were taken.
320, 330	Read in the samples.
350 to 370	Output the sample values to the screen.
420	Set the exit condition for the program loop.

Example 7

Function

This program measures the minimum and maximum of an incoming signal.

Listing

```
10 ON KBD GOTO Theend
20 Pmm=722
25 !
30 OUTPUT Pmm;"*RST,*CLS"
40 OUTPUT Pmm;"INIT1:CONT ON"
45 !
50 OUTPUT Pmm;"READ1:POW?"
60 OUTPUT Pmm;A
70 GOSUB Minmeas
80 GOSUB Maxmeas
85 !
90 LOOP
100 OUTPUT Pmm;"READ1:POW?"
110 ENTER Pmm;A
120 IF A<Minimum THEN GOSUB Minmeas
130 IF A>Maximum THEN GOSUB Maxmeas
140 END LOOP
145 !
150 Minmeas: Minimum=A
160 PRINT TABXY(4,12);"Minimum:      "
170 PRINT TABXY(13,12);Minimum
180 RETURN
185 !
190 Maxmeas: Maximum=A
200 PRINT TABXY(4,14);"Maximum:      "
210 PRINT TABXY(13,14);Maximum
220 RETURN
225 !
230 Theend: END
```

Example 7**Description****Line No.**

10	Execution goes to Exit when a key on the keyboard is hit.
20	Setting the address of the instrument (Address = 22).
30 to 40	Initializes the multimeter
50 to 80	Input a first reading into the variables for the minimum and maximum .
90 to 140	The main loop, where the current power is read in and compared with the minimum and maximum so far.
150 to 180	Set and display the new minimum value.
190 to 220	Set and display the new maximum value.
230	End the execution of the program.

Installation

This appendix provides installation instructions for the HP 8153A. It also includes information about initial inspection and damage claims, preparation for use, packaging, storage, and shipment.

Safety Considerations

The Model HP 8153A is a Class 1 instrument (that is, an instrument with an exposed metal chassis directly connected to earth via the power supply cable). The symbol used to show a protective earth terminal in the instrument is .

Before operation, you should review the instrument and manual, including the red safety page, for safety markings and instructions. You must follow these to ensure safe operation and to maintain the instrument in safe condition.

Some HP 8153A circuits are powered whenever the instrument is connected to the AC power source. To disconnect from the line power, disconnect the power cord either at the rear power-inlet or at the AC line-power source (receptacle). One of these must always be accessible. If the instrument is in a cabinet, it must be disconnected from the line power by the system's line-power switch.

A

Initial Inspection

Inspect the shipping container for damage. If there is damage to the container or cushioning, you should keep them until you have checked the contents of the shipment for completeness and verified the instrument both mechanically and electrically.

The Performance Tests give procedures for checking the operation of the instrument. If the contents are incomplete, mechanical damage or defect is apparent, or if an instrument does not pass the operator's checks, notify the nearest Hewlett-Packard office.

Warning



To avoid hazardous electrical shock, do not perform electrical tests when there are signs of shipping damage to any portion of the outer enclosure (covers, panels, etc.).

Line Power Requirements

The HP 8153A can operate from any single-phase AC power source that supplies between 100V and 240V at a frequency in the range from 50 to 60Hz. The maximum power consumption is 55VA with all options installed.



The fuse used by this instrument is T1A / 250V (slow) (HP Part No. 2110-0007). Changing the fuse should be carried out only by a qualified electrician or by HP service personnel as it is necessary to open the instrument.

Line Power Cable

In accordance with international safety standards, this instrument has a three-wire power cable. When connected to an appropriate AC power receptacle, this cable earths the instrument cabinet. The type of power cable shipped with each instrument depends on the country of destination. Refer to Figure A-1 for the part numbers of the power cables available.

A-2 Installation

Warning

To avoid the possibility of injury or death, you must observe the following precautions before switching on the instrument.

- If this instrument is to be energized via an autotransformer for voltage reduction, ensure that the Common terminal connects to the earthed pole of the power source.
 - Insert the power cable plug only into a socket outlet provided with a protective earth contact. Do not negate this protective action by the using an extension cord without a protective conductor.
 - Before switching on the instrument, the protective earth terminal of the instrument must be connected to a protective conductor. You can do this by using the power cord supplied with the instrument.
 - It is prohibited to interrupt the protective earth connection intentionally.
-

A 

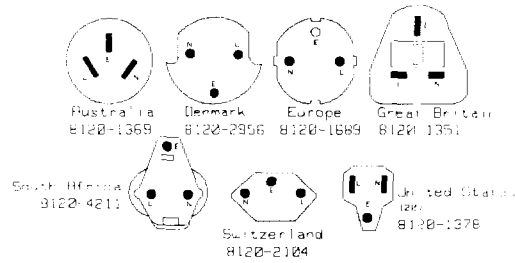

Figure A-1. Line Power Cables - Plug Identification

The following work should be carried out by a qualified electrician, and all local electrical codes must be strictly observed. If the plug on the cable does not fit the power outlet, or if the cable is to be attached to a terminal block, cut the cable at the plug end and rewire it.

The color coding used in the cable depends on the cable supplied. If you are connecting a new plug, it should meet the local safety requirements and include the following features:

- Adequate load-carrying capacity (see table of specifications).
- Ground connection.
- Cable clamp.

Operating Environment

The following summarizes the HP 8153A operating environment ranges. In order for the HP 8153A to meet specifications, the operating environment must be within these limits.

Warning



The HP 8153A is not designed for outdoor use. To prevent potential fire or shock hazard, do not expose the HP 8153A to rain or other excessive moisture.

Temperature

The HP 8153A may be operated in temperatures from 0°C to 55°C.

Humidity

The HP 8153A may be operated in environments with humidity up to 95% (0°C to +40°C). The HP 8153A should be protected from temperatures or temperature changes that cause condensation within the instrument.

Instrument Cooling

The HP 8153A has a cooling fan mounted internally. Mount or position the instrument so that air can circulate through it freely. When operating the HP 8153A, choose a location that provides at least 75mm (3inches) of clearance at the rear, and at least 25mm (1inch) of clearance at each side. Failure to provide adequate air clearance may result in excessive internal temperature, reducing instrument reliability.

Input/Output Signals

Caution A maximum of 15V can be applied as an external voltage to any of the BNC connectors.



HP-IB Interface

You can connect your HP-IB interface into a star network, a linear network, or a combination star and linear network. The limitations imposed on this network are as follows:

- The total cable length cannot exceed 20 meters
- The maximum cable length per device is 2 meters
- No more than 15 devices may be interconnected on one bus.

A**Cables and Adapters**

The HP-IB connector is compatible with the connectors on the following cables and adapter.

- HP-IB Cable, 10833A, 1 m (3.3 ft.)
- HP-IB Cable, 10833B, 2 m (6.6 ft.)
- HP-IB Cable, 10833C, 4 m (13.2 ft.)
- HP-IB Cable, 10833D, 0.5 m (1.6 ft.)
- HP-IB Adapter, 10834A, 2.3 cm. extender.

Connector

The following figure shows the connector and pin assignments.

Connector Part Number: 1251-0293

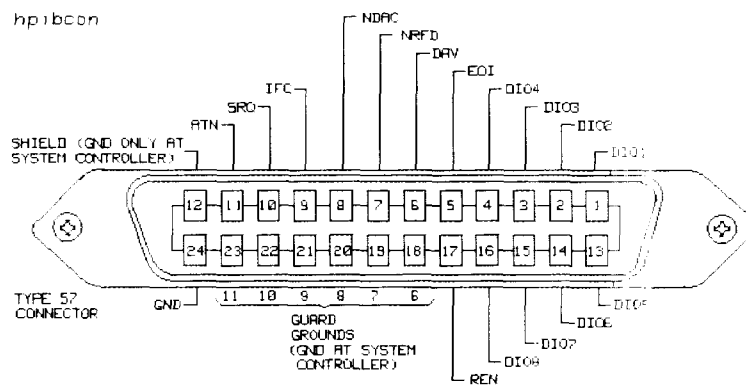

Figure A-2. HP-IB Connector

Caution

HP products delivered now are equipped with connectors having ISO metric-threaded lock screws and stud mounts (ISO M3.5x0.6) that are black in color. Earlier connectors may have lock screws and stud mounts with English threaded lock screws and stud mounts (6-32 UNC) that have a shiny nickel finish.

A-6 Installation

Caution

- It is recommended that you do not stack more than three connectors, one on top of the other.
 - Hand-tighten the connector lock screws. Do not use a screwdriver.
-

A **HP-IB Logic Levels**

The HP 8153A HP-IB lines use standard TTL logic, as follows:

- True = Low = digital ground or 0Vdc to 0.4Vdc
- False = High = open or 2.5Vdc to 5Vdc

All HP-IB lines have LOW assertion states. High states are held at 3.0Vdc by pull-ups within the instrument. When a line functions as an input, it requires approximately 3.2mA to pull it low through a closure to digital ground. When a line functions as an output, it will sink up to 48mA in the low state and approximately 0.6mA in the high state.

Note

The HP-IB line screens are not isolated from ground.



Removing and Fitting Modules

The unit can fit two single width modules, or one double width module.

How to Remove a Module

Caution

- Do not use the electrical or optical connectors to pull the module out of the instrument, as this can cause damage to the connectors.
 - Make sure that the line power is switched off before you remove a module.
-

A

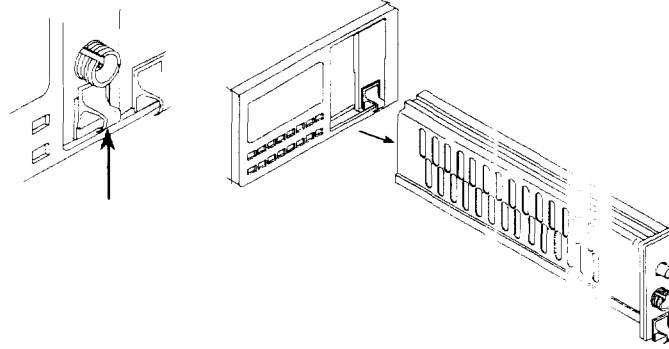

Figure A-3. How to Remove a Module

1. Lift the catch at the bottom front of the module.
2. With the catch lifted, pull the module out of the instrument. If the module does not slide out freely, check that you have lifted the catch high enough.

How to Fit a Module

Caution



- Do not use the electrical or optical connectors to push the module into the instrument, as this can cause damage to the connectors.
 - Make sure that the line power is switched off before you fit a module.
-

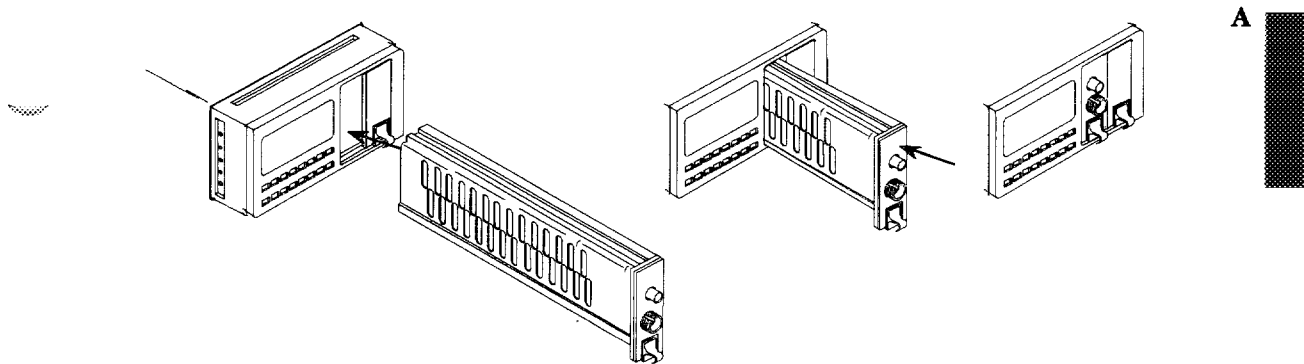

Figure A-4. Fitting a Module

1. Position the module at an unoccupied slot, with the catch at the bottom front of the module.
2. Insert the module into the slot and onto the tracks. If the module does not slide in freely, check that you have correctly positioned and correctly oriented it and that there is no obstruction to its movement.
3. Apply pressure to the front panel, and push the module as far as it goes. You hear a small click when the module reaches its installed position. This is the catch making contact.

Storage and Shipment

The instrument can be stored or shipped at temperatures between -40°C and $+70^{\circ}\text{C}$. The instrument should be protected from temperature extremes that may cause condensation within it.

Claims and Repackaging

If physical damage is evident or if the instrument does not meet specification when received, notify the carrier and the nearest Hewlett-Packard Service Office. The Sales/Service Office will arrange for repair or replacement of the unit without waiting for settlement of the claim against the carrier.

Return Shipments to HP

If the instrument is to be shipped to a Hewlett-Packard Sales/Service Office, attach a tag showing owner, return address, model number and full serial number and the type of service required.

The original shipping carton and packing material may be reusable, but the Hewlett-Packard Sales/Service Office will provide information and recommendation on materials to be used if the original packing is no longer available or reusable. General instructions for repacking are as follows:

1. Wrap instrument in heavy paper or plastic.
2. Use strong shipping container. A double wall carton made of 350- pound test material is adequate.
3. Use enough shock absorbing material (3 to 4 inch layer) around all sides of the instrument to provide a firm cushion and prevent movement inside container. Protect control panel with cardboard.
4. Seal shipping container securely.
5. Mark shipping container FRAGILE to encourage careful handling.
6. In any correspondence, refer to instrument by model number and serial number.

Accessories

B

Mainframe

Model No.	Mainframe Description
HP 8153A	Mainframe
Option 907	Front Handle Kit
Option 908	Rack Flange Kit
Option 916	Additional Operating and Programming Manual
Option 050	DC Input 12V to 30V†
Option 051	DC Power Cable (5m unterminated)‡

† If DC Power Cable required, order Option 051 as well.

‡ requires Option 050

Modules

Power Sensor Modules

Model No.	Description
HP 81530A*	+3 to -110dBm, Si, 450-1020nm
HP 81536A*	+3 to -70dBm, InGaAs, 800-1700nm
HP 81531A*	+3 to -90dBm, InGaAs, 800-1700nm
HP 81532A*	+3 to -110dBm, InGaAs, 800-1700nm
Option 916	Additional Operating and Programming Manual

* Requires a connector interface (see below)

Laser Source Modules

Model No.	Description
HP 81551SM*	850nm center wavelength, multimode
HP 81552SM*	1310nm center wavelength, single-mode
HP 81553SM*	1550nm center wavelength, single-mode
HP 81554SM*	1310/1550 single-mode
Option 916	Additional Operating and Programming Manual

* Requires a connector interface (see below)

Optical Head Interface Module

Model No.	Description
HP 81533A	850nm center wavelength, multimode
Option 916	Additional Operating and Programming Manual

The Optical Head Interface connects to the optical heads HP 81520A, HP 81521B, and HP 81522A.

B-2 Accessories

Connector Interfaces and Other Accessories

High Return Loss Interface

Model No.	Description
HP 81000RI	High Return Loss Interface

Connector Interface

Model No.	Description
HP 81000AI	Diamond HMS-10/HP
HP 81000FI	FC/PC
HP 81000JI	SMA
HP 81000SI	DIN 47256
HP 81000VI	ST
HP 81000WI	Biconic

Bare Fiber Adapter

Model No.	Description
HP 81000AB	Diamond HMS-10/HP
HP 81000FB	FC/PC
HP 81000VB	ST
HP 81000WB	Biconic

Caution



When you are using a bare fiber adapter, make sure that the fiber is correctly clamped. If the fiber protrudes too far, the fiber end can become easily damaged, or it can damage connectors to which you attach it.

Interactive Test Generator

Model No.	Description
E2020B	Interactive Test Generator II [†]

† This is a general instrument driver library which includes a HP 8153A driver. The version listed supports Windows languages and applications on the PC, as well as having tools for graphics mathematical analysis and file-I/O. We recommend that with this product you use Instrument BASIC for Windows (E2200A), and the HP 82335I HP-IB Interface Card.



B

B.4 Accessories

Specifications

The HP 8153A is produced to the ISO 9001 international quality system standard as proof of HP's commitment to continually increasing customer satisfaction through improved quality control.

Specifications describe the instrument's warranted performance. Supplementary performance characteristics describe the instrument's non-warranted typical performance.

Because of the modular nature of the instrument, the performance specifications apply to the modules rather than the mainframe unit. The specifications for a module are supplied with it. You should insert the appropriate pages into this section of the manual.

C

Mainframe Specifications

The mainframe has a dual channel display. For each channel there is a main display with six digits and an auxiliary display with eight characters.

C

Display ranges	
Power	+ 30 to -110dBm or 1000.00mW to 0.01pW
Calibration factor	±200.000dB
Reference	±200.000dBm/dB
Data Acquisition	
Memory	500 measurement results/channel (Data acquisition time ≥20ms/measurement result)
Selectable data averaging time	20ms to 60 minutes
Selectable total data averaging time	20ms to 99:59:59h
Environmental	
Storage temperature	-40°C to +75°C
Operating temperature	0°C to +55°C
Humidity	<95% R.H. from 0°C to +40°C
Power	AC 100 to 240Vrms±10%, 50 to 60Hz, 55VA max.
Dimensions	89mm H, 212.3mm W, 355mm D (3.5" x 8.36" x 14.0")
Weight	net 2.5kg (5.5lbs), shipping 4.5kg (9.9lbs)
HP-IB interface	
Function code	SH1, AH1, T6, L4, SR1, RL1, PP0, DC1, DT1, CO, E2 SCPI command set
HP-IB capability	modes and parameters can be programmed
Transfer time	20ms for one measurement result <800ms for 100 measurement results out of memory

C-2 Specifications

Declaration of Conformity

(according to ISO/IEC Guide 22 and EN45014)

Manufacturer: Hewlett-Packard GmbH
Böblingen Instruments Division
Herrenberger Straße 130
D-7030 Böblingen
Federal Republic of Germany

declares that the product

Product Name: Lightwave Multimeter
Model Numbers: HP 8153A and modules
Product Options: All

conforms to the following IEC-/EN- standards

Safety:	IEC 348:1978	HD 401 S1	
	IEC 825 + A1:1984	EN 60825 (1991)	(laser modules)
EMC:	CISPR 11:1990	EN 55011 (1991)	Group 1 Class B ⁽¹⁾
	IEC 801-2:1991	EN 50082-1 (1992)	4 kV CD, 8 kV AD [ESD]
	IEC 801-3:1984	EN 50082-1 (1992)	3 V/m [Radiated Immunity]
	IEC 801-4:1988	EN 50082-1 (1992)	0.5 kV, 1 kV [Fast Transients]

Supplementary Information:

The product also conforms to other standards not listed here. If you need information on conformance to particular standards, please contact your local Hewlett-Packard Sales and Service Office.

⁽¹⁾ The product was tested in a typical configuration with HP systems (Type test).

Böblingen, March 13, 1992

Robert Hofgärtner
Quality Assurance Manager

Acoustic Noise Emission

For ambient temperature up to 30°C

LpA = 42.5dB

Typical Operator position,
normal operation.

Data are results from type tests per ISO 6081.

Geräuschemissionswerte:

Bei einer Umgebungstemperatur bis 30°C

LpA = 42.5dB

am Arbeitsplatz,
normaler Betrieb.

C

Angabe ist das Ergebnis einer Typenprüfung nach DIN 45635 Teil 19.

Function Tests

Introduction

The procedures in this section test the electrical function of the instrument. The complete specifications to which the HP8153A is tested are given in Appendix C. All tests can be performed without access to the interior of the instrument.

Equipment Required

Equipment required for the Function Test is listed in the table below. Any equipment which satisfies the critical specifications given in the table may be substituted for recommended models.

Recommended Test Equipment

A. Head Adapter Module	HP 81533A
Optical Head	HP 81520A or HP 81521B
Test/Cal Box	P/N 08152-63201
Head Recognition Adapter	P/N 08152-63211
Digital Multimeter with Test Leads	HP 3466A
Test Cable	P/N 15414-61603
Oscilloscope	
OR	
B. Sensor Module	HP 81530/1/2/6A

Test Record

Results of the Function Test may be tabulated on the Test Record provided at the end of the test procedures. It is recommended that you fill out the Test Record and refer to it while doing the test. Since the test limits and setup information are printed on the Test Record for easy reference, the record can be also be used as an abbreviated test procedure (if you are familiar with test procedures). The Test Record can also be used as a permanent record and may be reproduced without written permission from Hewlett-Packard.

Test Failure

If the HP8153A fails any Function Test, return the instrument to the nearest Hewlett-Packard Sales/Service Office for repair.

D

Instruments Specifications

Specifications are the characteristics of the instrument which are certified. These specifications, listed in Appendix C are the limits against which the HP8153A can be tested. Appendix C also lists some supplemental characteristics of the HP8153A and should be considered as additional information.

Any changes in the specifications due to manufacturing changes, design, or traceability to the National Institute of Standards and Technology will be covered in a manual change supplement or revised manual. The specifications listed here supercede any previously published.

IA. Function Test Using the HP 81533A

The Function Test given in this section is using the HP 81533A Optical Head Interface Module and the 08152-63201 Test/Cal Box to check voltages and signals from and to the HP8153A Multimeter Mainframe.

Note



If you do not have an HP 81533A or a Test/Cal Box, it is possible to perform the function test with other modules. Go to "IB. Function Test using a HP 81530/31/32 or HP 81536A".

Perform each step in the tests in the order they are given using the corresponding test equipment.

Display Function and Module Interface Tests

Display Function Tests

1. Insert the HP81533A into the Multimeter channel A position and connect the Test/Cal Box to the HP8153A Input.
2. Make sure that the Head Recognition Adapter is connected to the Test/Cal Box.
3. Turn power on and check that all display segments are lit for approx. 2 seconds and the HP8153A displays E 3200 HEAD-DAT SELFTEST.
4. Press any key on the HP8153A to overwrite the error message.
5. Press the [Param] key until PARAM= CAL is displayed.
6. Using the [Modify] keys check that the CAL factor can be changed 200.000dB to -200.000dB and set the CAL factor back to 0.000dB by holding the [Param] key down for approx. 3 seconds.
7. Press the [Param] key until PARAM= T is displayed.
8. Using the [Modify] keys check that following measurement time settings can be selected: 60, 30, 20, 15, 10, 5, 2, 1 minutes. 30, 20, 10, 5, 2, 1 seconds. 500, 200, 100, 50, 20 milliseconds.
9. Select display in [dBm] and press the [Param] key until PARAM= REF is displayed.

D



10. Check that the REF can be changed from 200.000dBm to -200.000dBm and set REF back to 0.000dBm by holding the [Param] key down for approx. 3 seconds.
11. Press the [Param] key until λ is displayed.
12. Check that λ can be changed from 850nm to 1700nm and set λ back to 1300nm by holding the [Param] key down for approx. 3 seconds.

Note Perform the following tests with the HP 81533A first in Channel A and then in Channel B position.



Module Interface Tests

13. Using the Test Cable check the following DC levels at Test/Cal Box receptacles:

+ 15V, -15V, P.CTRL, STATUS
+ 15Volt + 15Volt ± 0.8 Volt
-15Volt -15Volt ± 0.8 Volt
P.CTRL 0Volt
STATUS 0Volt

Note When performing the following tests each time after pressing the switch on the Head Recognition Adapter ER 3200 HEAD-DAT will appear. To continue the tests or to repeat a test, the error state must be overwritten by pressing any key on the HP8153A front panel.

14. RANGE 0, RANGE 1

The states of RANGE 1 and RANGE 0 depend on the respective HP8153A range settings. Check the status of the range selection signal on the RANGE 1 and RANGE 0 receptacles on the Test/Cal. Box.

Switch AUTOrange OFF) and select the ranges with the Up and Down keys.

HP8153A dBm RANGE RANGE 0 RANGE 1

0	H	H
-10	H	H
-20	H	L
-30	H	L
-40	H	L
-50	L	L

Set the Oscilloscope as follows: Input to 2V/DIV, DC coupled, 1M Ω .
TIME/DIV to 0.005s/DIV; Sweep Mode to AUTO.

15. +5V
Using the Test Cable connect the +5V receptacle to the oscilloscope.
When pressing the switch on the Head Recognition Adapter, the +5V output should switch from 0V to +5V and back to 0V after approx. 2s.
16. MODE 0 (MODE 1)
Connect the Test Cable from the MODE 0 (MODE 1) receptacle to the oscilloscope.
When pressing the switch on the Head Recognition Adapter the MODE 0 (MODE 1) output should switch from 0V to approx. +5V and back to 0V after approx. 2s.
17. CLOCK
Using the Test Cable connect the CLOCK receptacle to the oscilloscope.
When pressing the switch on the Head Recognition Adapter the CLOCK output should show clock pulses for approx. 4 seconds, going from +5V to 0V.
18. \overline{OE}
Using the Test Cable connect the \overline{OE} receptacle to the oscilloscope.
When pressing the switch on the Head Recognition Adapter the \overline{OE} output should switch from + 5V to 0V and then back to + 5V.
19. ON/OFF
Set the Oscilloscope as follows: Input to 5V/DIV.
Using the Test Cable connect the ON/OFF receptacle to the oscilloscope.

D

A short program is given below that does the sending and receiving described above. This program is written in the BASIC 4.0 Language System used on HP 9000 series 200/300 computers.

```
10  !-----  
20  !  
30  ! HP 8153A HP-IB Function Test  
40  !  
50  !-----  
70  !  
80  ! Definitions and Initialisations  
90  !  
100 Mmadd=722  
110 DIM String$(80)  
120 !  
130 CLEAR SCREEN  
140 PRINT TABXY(5,10);"HP-IB Function Test"  
150 !  
160 ! Send an IDN query and get the identification  
170 !  
180 OUTPUT Mmadd;"*IDN?"  
190 ENTER Mmadd;String$  
200 PRINT TABXY(10,12);"Identification : ";String$  
210 !  
220 END
```

D

Function Test for the HP 8153A

Test Facility:

_____	Report No.	_____
_____	Date	_____
_____	Customer	_____
_____	Tested By	_____

Model HP 8153A Mainframe

Serial No. _____ Ambient temperature _____ °C

Options _____ Relative humidity _____ %

Firmware Rev. _____ Line frequency _____ Hz

D



Special Notes:

Function Test for the HP 8153A

Model HP 8153A Mainframe		No. _____		Date _____	
Test No.	Test Description	Channel A		Channel B	
		Pass	Fail	Pass	Fail
IA.	Display Function and Module Interface Test				
	Tested with HP 81533A Module and Test/Cal Box				
	Display All segments for approx. 2sec.				
	E 3200 HEAD-DAT SELFTEST				
	CAL factor 200.000dB to -200.000dB				
	Meas. Time T 60minutes to 20ms				
	REfERENCE 200.000dBm to -200.000dBm				
	λ 850nm to 1700nm				
	+15Volt +15Volt ±0.8Volt				
	-15Volt -15Volt ±0.8Volt				
	P.CTRL 0Volt				
	STATUS 0Volt				
	RANGE 0 High: 0dBm to -40dBm range				
	Low: -50dBm range				
	RANGE 1 High: 0dBm to -10dBm ranges				
	Low: -20dBm to -50dBm ranges				
	+5VOLT 0V → +5V → 0V				
	MODE 0 0V → +5V → 0V				
	MODE 1 0V → +5V → 0V				
	CLOCK Pulses from +5V to 0V				
	OE +5V → 0V → +5V				
	ON/OFF +5V → +15V → +5V				
	ANALOG IN Display approx. 12.500				
	P.CTRL Peltier Regulation				

D

Function Test for the HP 8153A

Model HP 8153A Mainframe		No. _____		Date _____	
Test No.	Test Description	Channel A		Channel B	
		Pass	Fail	Pass	Fail
IB.	Display Function and Module Interface Test Tested with HP 81530/1/2/6A Module All display segments on for approx. 2 sec. All keys (except Chan) Zero Zeroing Operation				
II.	HP-IB Function Test				

D

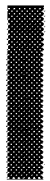



Cleaning Procedures

In general, *whenever possible use physically contacting dry connectors*. Fiber connectors may be used dry or wet. Dry means without index matching compound. If there is a need to use an index matching compound, use only HP index matching oil (part number 8500-4922). Clean the connectors, interfaces and bushings carefully each time after use.

Cleaning Materials

	HP P/N
Lens Cleaning Paper	9300-0761
Special Cleaning Tips	9300-1351
Blow Brush	9300-1131
Adhesive Cleaning tape	15475-68701
Isopropyl Alcohol	Not available from HP. This should be available from any local pharmaceutical supplier.
Pipe Cleaner	

Cleaning Fiber/Front-Panel Connectors

1. In order to clean the instrument front panel connector remove the connector interface.
2. Apply some isopropyl alcohol to the lens cleaning paper and clean the surface and the ferrule of the connectors.
3. Using a new dry piece of cleaning paper wipe the connector surface and ferrule until they are dry and clean.
4. Lightly press the adhesive tape several times against the connector surface to remove any remaining particles. After use store the tape in the container.
5. Protect the connector surface with a cap.

Cleaning Connector Interfaces

- * Apply some isopropyl alcohol to the pipe cleaner and wash the inside of the connector interface.
- * Using a new dry pipe cleaner, dry the inside of the connector interface.
- * Remove the brush part from the blow brush and blow air through the inside of the interface to remove any remaining particles.

Note



If any index matching compound was used, use an ultrasonic bath with isopropyl alcohol to clean the connector interfaces.

Cleaning Connector Bushings

As used on the HP 8158B and HP 81000AS/BS.

Normally the connector bushings require no cleaning. However, if it appears that cleaning is necessary, use only the blow brush with the brush part removed.

Caution



- NEVER insert any cleaning tool into the bushing as this may affect the optical system.
- NEVER use any index matching compound, cleaning fluid or cleaning spray.

Cleaning Detector Windows

As used on the HP 81520A and HP 81521B.

1. Use the blow brush to remove any particles from the surface.
2. Wipe the surface with cleaning paper or special cleaning tips.

E

Cleaning Lens Adapters

Caution

Do not use any cleaning fluid or cleaning spray.



1. Using the blow brush, remove dust.
2. Wipe the surfaces with the special cleaning tips.

Cleaning Detector Lens Interfaces

As used on the HP 81522A and HP 8140A and HP 8153A detector modules.

Normally, the lens interface can be cleaned by using the blow brush. If adhesive dirt must be removed perform as follows:

1. Using the blow brush, remove the dust from the lens surface.
2. Press the special cleaning tip to the lens surface and rotate the tip.

Note



Use alcohol for cleaning only then when above procedure does not help or if the dirt is caused by oil or fat.

E

Local Control Summary

Chan	selects the channel. Under remote operation , this key acts as Local .
Mode	changes the operating mode.
←, →	select the character to edit.
↓, ↑	edit the selected character.

Measure Mode

The mode-indicator shows MEAS. In measure mode, the function of key is shown by the black legend on the key.

Param	selects measurement-parameters.
λ	This is the wavelength value.
CAL	This is a calibration offset.
T	This is the length of time over which a signal is averaged.
REF	This parameter sets the reference-level.
ATT	This parameter sets the attenuation of an output.
AUX	This parameter sets the frequency of the modulation of the output.
Disp→Ref	takes the input power-level and stores it as the reference.
dB	switches the display to show results in dB; with respect to the reference stored for the channel; or, for an instrument with two sensors, with respect to the power-level of the other channel.
dBm/W	changes the display to show results in dBm or in Watts.
Zero	removes any electrical offset in the sensor circuitry.
N Dig	selects the number of digits shown after the decimal point.
Auto	enables or disables automatic ranging for the result.
Up	selects the next higher range and disables automatic ranging.
Down	selects the next lower range and disables automatic ranging.

Menu Mode

The mode-indicator shows MENU. In this mode the blue legends, above the keys, show the commands available to the user.

System	changes the instrument to system mode.
Loss	starts the loss application.
Record	starts the record applications.
STABILTY	Samples power over a specified period of time. T_TOTAL is total time. AUTODUMP enables the automatic dump to the printer or plotter.
LOGGING	Takes sample of the power in rapid succession. SAMPLES sets the number of samples that are to be taken. AUTODUMP enables or disables the automatic plotting or printing of the samples when the application finishes. START works together with THRESHLD to determine the conditions to be met before the application starts. THRESHLD sets the threshold power that must be crossed before the application starts.
MAN LOGG PLOT and PRINT	Takes a sample each time you press Exec . Dump the samples to a printer or plotter. AUTOSCAL enables or disables automatic scaling of the plot. Y_MIN sets the minimum value on the y-axis of the plot. Y_MAX sets the maximum value on the y-axis of the plot. COMMENT is an eight character message printed on the plot for identification.
More	gets you into the other applications. The full list of these applications depends on the modules installed.
SHOW	Shows the samples on the display. MAXIMUM shows the maximum power-level sampled. MINIMUM shows the minimum power-level sampled. DIFF shows the difference between the minimum and maximum power-levels sampled. AVERAGE shows the mean average of the samples.

F

	# 1	shows the first of the samples taken. To examine the rest of the samples, use the Modify keys.
ALIGNMNT	TYPE	sets whether the instrument automatically records the maximum power-level, or the user sets the maximum power-level.
	DELTA	sets the range of power shown by the graphic bar.
	MAXPOWER	sets the maximum power-level.

Edit

enables or disables the editing of parameters.

Exec

Runs or stops an application.

Pause

Pauses or continues an application.

Prev

selects the previous in a series of applications or parameters.

Next

selects the next in a series of applications or parameters.

System Mode

The mode-indicator shows MENU SYS at the top of the display.

RECALL Recall a configuration that is stored in memory.

- The module type is indicated by the last two numeric digits of the product number.
- The location where the configuration data is stored. This number is displayed to the left of the arrow.

The channel is either the letter A or the letter B. It is displayed to the right of the arrow.

STORE Store a configuration into memory.

- The module type is shown for the last data that was stored in the selected location.
- The channel is either the letter A or the letter B. It is displayed to the left of the arrow.
- The location where the configuration data will be stored is a number between 1 and 9. This number is displayed to the right of the arrow.

HPIB Set the HP-IB parameters.

ADDRESS to set the HP-IB address of the instrument.

MODE to set the instrument to control or talk-only operation.

F

	LANGUAGE	to set whether the instrument is to run in HP 8152A compatible mode or not.
DISPLAY		set the display parameters.
	BRIGHT	sets the brightness of the display.
DATETIME		set the date and the time.
	MM/DD/YY	sets the date.
	HH:MM:SS	sets the time.

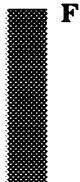

HP 8153A HP-IB Command Summary

HP-IB Capabilities

Mnemonic	Function
SH1	Complete source handshake capability
AH1	Complete acceptor handshake capability
T6	Basic talker; serial poll; unaddressed to talk if addressed to listen; no talk only
L4	Basic listener; unaddressed to listen if addressed to talk; no listen only
SR1	Complete service request capability
RL1	Complete remote/local capability
PP0	<i>No parallel poll capability</i>
DC1	Device clear capability
DT1	Device trigger capability (accepted but ignored)
C0	No controller capability
E2	Tristate outputs (except the handshake lines)

HP-IB Bus Commands

Command	Description	Treatment
DAB	Data byte	Implemented as usual
DCL	Device clear	Sets 8153 into reset state, see section "The Parser"
EOI	End or identify	End is treated as white space
GET	Group execute trigger	Not implemented
GTL	Go to local	Transparent to the parser
IFC	Interface clear	Transparent to the parser
LAG	Listen address group	Transparent to the parser
LLO	Local lock out	Transparent to the parser
MLA	My listen address	Not implemented
MTA	My talk address	Not implemented
PPC	Parallel poll config.	Not implemented
PPD	Parallel poll disable	Not implemented
PPE	Parallel poll enable	Not implemented
PPU	Parallel poll unconfig.	Not implemented
PPOLL	Parallel poll	Not implemented
REN	Remote enable	Transparent to the parser
SDC	Selected device clear	See DCL
SPD	Serial poll disable	Transparent to the parser
SPE	Serial poll enable	Transparent to the parser
TAD	Talk address	Transparent to the parser
TCT	Take control	Not implemented
UNL	Unlisten	Transparent to the parser
UNT	Untalk	Transparent to the parser

G

G-2 Remote Operation

Common Command Summary

Command	Function
*CLS	Clear Status Command
*ESE	Standard Event Status Enable Command
*ESE?	Standard Event Status Enable Query
*ESR?	Standard Event Status Register Query
*IDN?	Identification Query
*OPC	Operation Complete Command
*OPC?	Operation Complete Query
*RST	Reset Command
*SRE	Service Request Enable Command
*SRE?	Service Request Enable Query
*STB?	Read Status Byte Query
*TRG	Trigger Command
*TST?	Self Test Query
*WAI	Wait Command

ABORt Command Summary

Command Parameter

ABORt[1|2]

DISPlay Command Summary

Command	Parameter	Note
DISPlay		
:BRIGHtness	<value>	w/o unit
:BRIGHtness?		
[:STATe]	<boolean>	
[:STATe]?		

FETCh Command Summary

Command Parameter

FETCh[1|2]
 [:SCALAr]
 :POWER
 [:DC]?

G

INITiate Command Summary

<u>Command</u>	<u>Parameter</u>
INITiate[1 2]	
	[:IMMediate]
	:CONTinuous <boolean>
	:CONTinuous?

PROGram Command Summary

<u>Command</u>	<u>Parameter</u>	<u>Note</u>
PROGram[1 2]		
	:[:SElected]	
	:EXECute	
	:NAME <application>	
	:NAME?	
	:NUMBer <varname>,<value>	
	:NUMBer? <varname>	
	:STATe CONTinue PAUSE RUN STOP 0 1 2 3	
	:STATe?	

The Logging Application

application

LOGGING

Parameters

G

- varname = SAMPLES

1 ≤ value ≤ 500

- varname = LOGGSTART

value = 1|2|3 where

- 1 means start when the input power-level is above threshold.
- 2 means start when the input power-level is below threshold.
- 3 means start immediately.

G-4 Remote Operation

- varname = THRESHOLD
-400.00 ≤ value ≤ 400.00

Results

- varname = ASAMPLES
- varname = RESULT

The Stability Application

application

STABILITY

Parameters

- varname = T_TOTAL
0 ≤ value ≤ 359,999

Results

- varname = ASAMPLES
- varname = RESULT

READ Command Summary

Command Parameter

READ[1|2]
[:SCALar]
:POWER
[:DC]?

G

SENSe Command Summary

Command	Parameter	Note
SENSe[1 2]		
:POWer		
:ATIME	<value>[<unit>]	
:ATIME?		
:RANGe		
[:UPPER]	<value>[<unit>]	
[:UPPER]?		
:AUTO	<boolean>	
:AUTO?		
:WAVElength	<value>[<unit>]	
:WAVElength?		
:REFEreNce	TOA TOB TOREF 0 1 2,<value>[<unit>]	
:REFEreNce?	TOA TOB TOREF 0 1 2	
:STATe	<boolean>	
:STATe?		
:RATIo	TOA TOB TOREF 0 1 2	
:RATIo?		
:DISPlay	TOA TOB TOREF 0 1 2	no query
:UNIT	<unit>	
:UNIT?		
:CORRection		
:COLLect		
:ZERO		
:ZERO?		
[:LOSS		
[:INPut		
[:MAGNitude]]]	<value>	cal factor
[:MAGNitude]]]?		cal factor

G

SOURce Command Summary

Command	Parameter
SOURce[1 2]	
:AM	
[:INTERNAL]	
:FREQuency	<value>[<unit>] CW
:FREQuency?	
:POWER	
:ATTenuation[1 2]	<value>[<unit>]
:ATTenuation[1 2]?	
:STATE	<boolean>
:STATE?	
:WAVElength	UPPER LOWER BOTH
:WAVElength?	

G

Table G-1. STATUS Command Summary

Command	Parameter
‡ is being used as shorthand for	:CONDition?
	:ENABle
	:ENABle? <value>
	[:EVENT]?
	:NTRansition <value>
	:NTRansition?
	:PTRansition <value>

STATUS

- :OPERation ‡
- :SETTling ‡
 - :LPELTier ‡
 - :HPELTier ‡
- :MEASuring ‡
 - :POWer ‡
- :TRIGger ‡
 - :POWer ‡
- :CORReCting ‡
 - :ZERO ‡
- :AVERaging ‡
 - :POWer ‡
- :PROGram ‡
 - :<application> ‡



Table G-2. STATus Command Summary

Command	Parameter
‡ is being used as shorthand for	
	:CONDition?
	:ENABle
	:ENABle? <value>
	[:EVENT]?
	:NTRansition <value>
	:NTRansition?
	:PTRansition <value>

STATus

- :QUESTionable ‡
- :POWer ‡
- :OVERRange ‡
- :LCURRent ‡
- :HCURRent ‡
- :LMONitor ‡
- :HMONitor ‡
- :ENVTemp ‡
- :ISUMmary ‡
- :INSTrument[1|2] ‡
- :POWer ‡

STATus:SOURce Command Summary

Command	Parameter
STATus	
:SOURce	
	:CONDition?
	:ENABle
	:ENABle? <value>
	[:EVENT]?
	:NTRansition <value>
	:NTRansition?
	:PTRansition <value>
	:PTRansition?

G

SYSTem Command Summary

Command	Parameter	Note
SYSTem		
:ERRor?		Query only
:DATE	<year>, <month>, <day>	2 char. each/4 char. for year
:DATE?		
:TIME	<hour>, <minute>, <second>	2 char. each
:TIME?		



G

G-10 Remote Operation

HP 8152A HP-IB Command Summary

The HP 8153A offers you a compatibility mode where you can program the instrument using the HP-IB commands for the HP8152A Average Power Meter. A summary of this set of commands is given here. For more details refer to the HP 8152A Operating and Programming manual. (HP part number 08152-90001).

Differences

Note

Dissimilarities in hardware and the principles of local operation, mean that in some cases differences between the HP 8152A and the HP 8153A in compatibility mode cannot be avoided.

1. The DB(MW) unit is no longer available. Use DBM instead.
2. In the standard parameter set, the AUTO ranging is no longer set to off. AUTO ranging is set to on, this also means that the Range is not set to 0dBm.
3. The CAL? and WCAL? queries are no longer available.
4. The power reading can no longer be made by just reading a value from the output queue. A query command must be sent to make a reading. Use the FETCh query as described in the TMSL mode. An example of using FETCh is given after this list.
5. When there is no sensor in one of the channels, the CH3 command sets the System Error bit (bit 7) and the Parameter Error bit (bit 0) in the status byte. The channel selection is not changed.
6. When an attempt is made to read the wavelength of a channel which has no sensor, with the WVL? command, the response is undefined.
7. The responses for the ERR? and LERR? queries are

- 100 Zero failed, channel A.
- 142 Head read error, channel A.
- 200 Zero failed, channel B.
- 242 Head read error, channel B.

- 8. Avoid altering parameters under local control when the instrument is also being controlled over the HP-IB in compatibility mode. It is possible to alter the parameters in such a way that the instrument no longer behaves like an HP 8152A.

Note



When in compatibility mode, altering the units (dBm, dB, Watts) under local control will not change the units used under remote control.

- 9. On the occurrence of a syntax error in compatibility mode, the parser resynchronizes at the start of the next line. Any commands following the syntax error on the same line, will be ignored. The HP 8152A resynchronizes on the next command that it recognizes.

Example Two lines in a program are:
CH1;Q1;CH2;U1
CH?

The Q1 command will cause a syntax error.

The HP 8152A selects channel A. After the syntax error it continues with selecting channel B and setting the units there to Watts. It will respond with 2 to the query.

The HP 8153A in compatibility mode selects channel A. After the syntax error the rest of the line is ignored. It will respond with 1 to the query.

- 10. The setting for the instrument in compatibility mode is not stored in the battery backed up memory.



H

H-2 Remote Operation

Using the FETCh Command - An Example

This example is a subroutine to take a reading from the second channel of the power meter. The original program, as written for the HP 8152A is given on the left. The modified program, to run on the HP 8153A (in HP8152A Compatability mode), is given on the right.

Old Program (HP 8152A)	New Program (HP 8153A)
.....
1300 SUB Single'meas(P\$)	1300 SUB Single'meas(P\$)
1310 CLEAR Pmm	1310 CLEAR Pmm
1320 OUTPUT Pmm;"CSB"	1320 OUTPUT Pmm;"CSB"
1330 OUTPUT Pmm;"WVL 2,1301NM;M2;CH2;U1;T1;AR1"	1330 OUTPUT Pmm;"WVL 2,1301NM;M2;CH2;U1;T1;AR1"
1340 TRIGGER Pmm	1340 TRIGGER Pmm
1350 S-SPOLL(Pmm)	1350 S-SPOLL(Pmm)
1360 IF BIT(S,2)-0 THEN GOTO 1350	1360 IF BIT(S,2)-0 THEN GOTO 1350
1370 ENTER Pmm;P\$	1365 OUTPUT Pmm;"FETC:POW?"
1380 OUTPUT Pmm;"CSB"	1370 ENTER Pmm;P\$
1390 LOCAL Pmm	1380 OUTPUT Pmm;"CSB"
1400 SUBEND	1390 LOCAL Pmm
.....	1400 SUBEND

Note



Do not specify a channel as part of the FETCh command, that is, the syntax for the command in the compatability mode is FETCh[:SCALar]:POWer[:DC]?

Line No.

- | | |
|------------|--|
| 1300 | Declares the subroutine. P\$ is the string in which the reading is returned to the calling program. |
| 1310 | Clears all the HP-IB buffers. (Pmm is the HP-IB address of the instrument) |
| 1320 | Clears the Status Byte in the instrument. |
| 1330 | Sets up the instrument: Sets the wavelength for channel 2 to 1301nm; select MEASure mode; select channel 2; select dBm as the units; set the trigger on; enable autoranging. |
| 1340 | Trigger the instrument. |
| 1350, 1360 | Performs a serial poll of the instrument, until bit 2 in the Status Byte is set. |
| 1365 | This is the extra command required by the HP 8153A when in HP 8152A compatability mode to read a value |

H

1370 Read the value.
1390, 1400 Return the instrument to local state, and leave the subroutine.

Setting the Filter

The filter command on the HP 8152A selects between a 2Hz (filter ON) and an 8Hz (Filter OFF) low pass filter.

This filter is not available on the HP 8153A. The filter command in HP 8152A Compatability mode selects between an averaging time of 500ms (filter ON) and an averaging time of 200ms (filter OFF).

Switching the instrument into HP 8152A Compatability mode, does not alter the averaging time. You should use *RST, or a filter ON or OFF command to set the averaging time to 500ms or 200ms.

H

H-4 Remote Operation

Listener Function

Settings

Parameter/Operation	Mnemonic	Data	Unit	Comment
Select SET Mode	M	1		
Select MEASure Mode	M	2		
Select Channel A	CH	1		
Select Channel B	CH	2		
Select B/A Operation	CH	3		
Autoranging Off	AR	0		
Autoranging On	AR	1		
Zero Off	ZER	0		
Zero On	ZER	1		

Parameter/Operation	Mnemonic	Data	Unit	Comment
Filter Off Settings	F	1,0		Channel A
	F	2,0		Channel B
	F	3,0		B/A operation
Filter On Settings	F	1,1		Channel A
	F	2,1		Channel B
	F	3,1		B/A operation
Select dBm Units	U	0		
Select Watts	U	1		
Select dB Units	U	2		
Select Trigger Off	T	0		continuous operation
Select Trigger On	T	1		single cycle operation
Set Channel A Range	RNG	1,<value>	DBM	-90 ≤ value ≤ +30, head dependent
Set Channel B Range	RNG	2,<value>	DBM	-90 ≤ value ≤ +30, head dependent
Set Channel A λ	WVL	1,<value>	M MM UM NM PM	default unit
Set Channel B λ	WVL	2,<value>	M MM UM NM PM	default unit
Set CAL for Channel A	CAL	1,<value>	DB	
Set CAL for Channel B	CAL	2,<value>	DB	
Set REF for Channel A	REF	1,<value>	DBM W MW UW NW PW	If no units are defined default is determined by the "U" command setting

H

H-6 Remote Operation

Parameter/Operation	Mnemonic	Data	Unit	Comment
Set REF for Channel B	REF	2, <value>	DBM W MW UW NW PW	
Set REF for B/A Mode	REF	3, <value>	DB	
Set SRQ mask	SRE	<value>		$0 \leq \text{value} \leq 191$, integer a 1 in the binary equivalent sets SRQ on this condition
Clear Status Byte	CSB			independent of SRQ state
Clear Device	CLR			Clears all input and output buffers.
Trigger	TRG			

Standard Parameter Set

Parameter/Operation	Mnemonic	Comment
Recall Standard Parameter Set	RST	The settings are as follows Measure mode Channel A AUTO-ranging off ZERO off Filter off Units dBm Range 0dBm Reference value 0dB/1mW CAL factor 0dB λ head dependent

Talker Function

Interrogating Settings

Parameter/Operation	Mnemonic	Comment
Learn Mode	LRN?	Returns 200-character string detailing all settings. See below this table for more details.
Interrogate Mode Setting	M?	Returns integer (1 2) for mode settings
Interrogate Channel Setting	CH?	Returns integer (1 2 3) for channel settings
Interrogate Autorange Setting	AR?	Returns integer (0 1) for off/on
Interrogate Zero Setting	ZER?	Returns integer (0 1) for off/on
Interrogate Units Setting	U?	Returns integer (0 1) for off/on
Interrogate Trigger Setting	T?	Returns integer (0 1) for continuous or single cycle mode
Interrogate Filter Setting	F? 1 2 3	Returns integer (0 1) for off/on for the selected channel
	F?	Returns 3 integers separated by commas for each of the filter settings
Interrogate Range Setting	RNG? 1 2	Returns a 7-character string for the range for the selected channel
	RNG?	Returns a 15-character string for the range settings of both channels
Interrogate λ Setting	WVL? 1 2	Returns an 11-character string for the λ for the selected channel
	WVL?	Returns a 23-character string for the λ settings for both channels.

H

Parameter/Operation	Mnemonic	Comment
Interrogate REF Setting	REF? 1 2 3	Returns a 7-character string for REF setting for the selected channel if dBm or dB are the current units Returns 11 characters if watts are the current units
	REF?	Returns a 23 character string for REF setting for the selected channel if dBm or dB are the current units Returns 35 characters if watts are the current units

The string for learn mode has the following format

Setting	Byte Position	Length
Mode	1-4	4
Trigger	5-8	4
Units	9-12	4
AUTO-ranging	13-17	5
Channel	18-22	5
Filter A, B, B/A	23-28, 29-34, 35-40	6, 6, 6
Zero	41-46	6
SRQ mask	47-54	8
Range A, B	55-68, 69-82	14, 14
CAL factor A, B	83-98, 97-110	14, 14
REF value A, B, B/A	111-128, 129-146, 147-164	18, 18, 18
λ A, B	165-182, 183-200	18, 18

H

Status/Error Reporting

Parameter/Operation	Mnemonic	Comment
Status Byte	STB?	Returns 3-digit integer (000-191)
Status Byte Mask	SRE?	Returns 3-digit integer (000-191)
Condition Byte	CNB?	Returns 2-digit integer (00-63)
Self-test	TST?	Executes self-test, returns 0 for pass and 1 for fail
Error Number	ERR?	Returns 3-digit integer representing error code
Last Error Number	LERR?	Returns 3-digit integer for last active error This is a destructive readout.
Operation Complete	OPC?	1 if no further commands to interpret and execute in the input buffer 0 if further commands in the input buffer
Identifier	IDN?	Returns 56-character string identifying currently installed firmware, manufacturer, model no. and serial number.
	IDN?1 2	Returns 26 character string identifying currently installed firmware, manufacturer model no. and serial number of channel A or B optical head.

Universal Commands

Command	ASCII Character	Binary	Octal	Decimal
Device Clear	DC ₄	00010100	024	20
Selected Device Clear	EOT	00000100	004	4
Group Execute Trigger	BS	00001000	010	8

H

H-10 Remote Operation

Error Codes

Local Operation Error Codes

Most of these errors are not fatal. You can use the instrument again by pressing any of the front panel keys.

Module Related Errors

- E 0101 Error in the low wavelength monitor current.
- E 0102 Error in the high wavelength monitor current.
- E 0103 Error in the low wavelength laser diode current.
- E 0104 Error in the high wavelength laser diode current.
- E 1xxx LIGHT Error while zeroing. Digits marked x indicate the phase, loop counter value, and hardware.
- E 3000 NO HEAD No head attached to the optical head interface module.
- E 3100 SETTLING Module not yet adjusted to temperature.
- E 3200 Checksum error in optical head data.
- E 3300 No memory to store the zero data (memory allocation failure).
- E 3400 NO HEAD Optical head removed during the zero operation.
- E 4001 MODULE Reading EEPROM failed.
- E 4002 MODULE EEPROM checksum error.
- E 4004 MODULE No acknowledge from EEPROM.
- E 4005 MODULE reading EPROM failed.
- E 4006 KEY JAM reading EPROM failed.

Specific Error Identifiers

- E 4010 Input value exceeds limits
- E 4020 Input value below lower limit
- E 4030 Registers of the real time clock cannot be read from or written to.

Store and Recall Errors

- E 4101 CH EMPTY Store from or recall to an empty slot.
- E 4102 MISMATCH Attempt to recall source data into a sensor module, or sensor data into a source module.
- E 4103 NO DATA Attempt to recall data from a location where no data has been stored, or where the data is unintelligible.
- E 4105 MEM FAIL Memory checksum failed.

Plot, Print, Show, and Manual Logging Errors

- E 4201 NO DATA There is no data for the application. Another cause could be that there is not enough data for the results statistics to be calculated.
- E 4202 INVALID The data is invalid.
- E 4203 TLKONLY? Plot or print is not possible because the HP-IB is not set to talk only mode.

Loss Errors

- E 4301 CONFIG The Loss application cannot run, because it needs both a source and a sensor module.
- E 4302 CONFIG The Loss application cannot run, because it needs one of the modules is already being used.

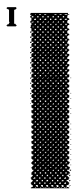

HP-IB Errors

These are fatal errors.

- E 8100 Status open in HP 8153 language mode.
- E 8110 Status open in HP 8152 language mode.
- E 8120 Status open in command extension.
- E 8200 HP-IB open in HP 8153 language mode.
- E 8210 HP-IB open in HP 8152 language mode.
- E 8220 HP-IB open in command extension.
- E 8300 Macro open in HP 8153 language mode.
- E 8301 Memory allocation failed.
- E 8310 Macro open in HP 8152 language mode.
- E 8400 Language processing terminated in HP 8153 language mode.
- E 8410 Language processing terminated in HP 8152 language mode.

HP-IB Error Codes

No Error

This message indicates that there are no errors.

- 0 No error [OK; error queue is empty].

Instrument Specific Errors

These error codes are all positive numbers.

- 110 Channel is empty.
- 120 Other channel is empty.
- 130 Command\query not available.
- 210 Logical parameter overflow [e.g. wavelength too small].
- 220 Invalid date information.

310	Invalid reference mode [e.g. A/A].
410	Real time clock error.
510	Head connection error [head not connected].
610	Error in the low wavelength laser diode current in channel A.
620	Error in the low wavelength laser diode current in channel B.
630	Error in the high wavelength laser diode current in channel A.
640	Error in the high wavelength laser diode current in channel B.
710	Error in the low wavelength monitor current in channel A.
720	Error in the low wavelength monitor current in channel B.
730	Error in the high wavelength monitor current in channel A.
740	Error in the high wavelength monitor current in channel B.
810	Zeroing failed in channel A.
820	Zeroing failed in channel B.

Command Errors

These error codes have numbers in the range -199 to -100. They indicate a syntax error has been detected by the parser, this could be

- A syntax error.
- A semantic error (unrecognised command)
- A Group Execute Trigger (GET) was put in the input buffer inside a program message.

The command error bit is set in the Event Status Register, see “*ESR?” in Chapter 6.

-100	Command error [generic syntax or semantic error].
-101	Invalid character.
-102	Syntax error [unrecognised command or data type].
-103	Invalid seperator.
-104	Data type error [e.g. numeric or string expected, got block data].
-105	GET not allowed.

I-4 Error Codes

- 108 Parameter not allowed [too many parameters].
- 109 Missing parameter [too few parameters].
- 110 Command header error.
- 111 Header separator error [whitespace, and nothing else, expected].
- 112 Mnemonic too long [maximum 12 characters].
- 113 Undefined header [operation not allowed].
- 114 Header suffix out of range.
- 120 Numeric data error [includes non-decimal numeric].
- 121 Invalid character in number [includes "9" in octal data, etc.]
- 123 Exponent too large [numeric overflow; exponent magnitude >32,767].
- 124 Too many digits [number too long; more than 255 digits received].
- 128 Numeric data not allowed.
- 130 Suffix error.
- 131 Invalid suffix [unrecognised units, or units not appropriate].
- 134 Suffix too long.
- 138 Suffix not allowed.
- 140 Character data error.
- 141 Invalid character data [bad character, or unrecognised].
- 144 Character data too long [maximum length is 12 characters].
- 148 Character data not allowed.
- 150 String data error.
- 151 Invalid string data [e.g., END received before close quote]
- 158 String data not allowed.
- 160 Block data error.
- 161 Invalid block data [e.g., END received before close quote]
- 168 Block data not allowed.
- 170 Expression error
- 171 Invalid expression [e.g, illegal character in expression]

-178 Expression data not allowed.

Execution Errors

These error codes are in the range -299 to -200. They indicate that an error has been detected by the part of the instrument that controls command execution.

- Data is out of range.
- The command could not be executed because of hardware limitations.

The Execution Error bit is set in the Event Status Register, see “*ESR?” in Chapter 6.

- 200 Execution error [generic].
- 201 Invalid while in local [only available in remote, otherwise conflict with hard local-control may result].
- 202 Settings lost due to ???
- 210 Trigger error.
- 211 Trigger ignored [new trigger received before old data read]
- 212 Arm ignored.
- 213 Init ignored.
- 214 Trigger deadlock.
- 215 Arm deadlock.
- 220 Parameter error.
- 221 Settings conflict [uncoupled parameters].
- 222 Data out of range [e.g. wavelength too high for this instrument].
- 223 Too much data [out of memory; block, string, or expression too long].
- 224 Illegal parameter value [used where exact value, from a list of possibles, was expected].
- 230 Data corrupt or stale [possibly invalid data; new reading started but not completed since last access].
- 231 Data questionable [measurement accuracy is suspect].
- 240 Hardware error.
- 241 Hardware missing [option not installed].

I-6 Error Codes

- 260 Expression error.
- 261 Math error in expression [e.g., divide by zero]
- 280 Program error.
- 281 Cannot create program.
- 282 Illegal program name.
- 283 Illegal variable name.
- 284 Program currently running.
- 285 Program syntax error.
- 286 Program runtime error.

Device Dependant Errors

These error codes are in the range -399 to 300. They indicate a failure due to an abnormal hardware or firmware condition. These codes are also used for the results of the self-test. The Device Dependant Error bit is set in the Event Status Register, see “*ESR?” in Chapter 6.

- 300 Device dependent error [generic failure message].
- 310 System error.
- 311 Memory error [this message, or any in the range -319 to -310, may be generated by checksum or parity errors].
- 312 Protected user data memory lost [data no longer available].
- 313 Calibration memory lost [out of calibration due to memory failure].
- 314 Save/Recall memory lost [cannot complete *RCL request].
- 315 Configuration memory lost.
- 330 Self-test failed [more specific data after “;”].
- 350 Too many errors (more than 30) [error queue overflow].

Query Errors

Query errors have codes in the range -499 to -400. they indicate that a problem has been detected in the output queue. This could be

- Trying to read from the queue when the queue is empty, or
- Data lost from output queue.

The Query Error bit is set in the Event Status Register, see ““ESR?” in Chapter 6.

- 400 Query error.
- 410 Query interrupted [query followed by a DAB or a GET before the response was complete].
- 420 Query unterminated [addressed to talk, incomplete program message received].
- 430 Query deadlocked [the input buffer and the output buffer are full; cannot continue].
- 440 Query unterminated after indefinite response [the indefinite response is no the last request in the message unit].

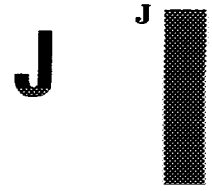

Sales and Service Offices

Hewlett-Packard products are sold and supported through HP offices worldwide. To contact the closest HP Sales and Service Office, please check your telephone directory, or contact one of the HP offices listed below.

Sales and Service Offices		
Country	Address	Tel.
France	Hewlett-Packard France Z.A. de Courtaboeuf 1, av. du Canada F-91947 Les Ulis Cédex	(33/1) 69-82-60-60
German Federal Republic	Hewlett-Packard GmbH Vertriebszentrum Südwest Schickardstrasse 2 D-7030 Böblingen	(49/7031) 645
Italy	Hewlett-Packard Italiana S.p.A. Via G.di Vittorio,9 I-20063 Cernusco S/N (Milano)	(39/2) 923-691
Japan	Yokogawa-Hewlett-Packard 1-27-15, Yabe Sagamihara Kanagawa, 229	(81/427) 59-1311
Spain	Hewlett-Packard Española, S.A. Crta. de la Coruña, Km. 16,500, E-28230 Las Rozas Madrid	(34/1) 6370011



J

Sales and Service Offices (continued)

Country	Address	Tel.
United Kingdom	Hewlett-Packard Ltd. King Street Lane Winnersh, Wokingham Berkshire RG11 5AR	(44/734) 784 774
United States	Hewlett-Packard Co. 120 W. Century Road Paramus, NJ 07653	(1/201) 599-5000

K

Backdating

K

Instruments with Serial Numbers 2946G00475 and Earlier

The units on the y-axis of the graph are either dBm or dB. The plot or printout is not scaled in Watts.

Instruments with Serial Numbers 2946G00225 and Earlier

The Print Application

K

In the Print application the instrument takes the samples from a Stability or Logging application and generates a printout of the samples. You can only printout the samples from the most recent Stability or Logging or Manual Logging application.

When you select the Print application the character field shows PRINT. This application has two parameters. SAMPLE sets the number of samples printed out. COMMENT is an eight character message printed on the printout for identification.

Press **Edit** to look at, or edit the parameter. While you are editing a parameter, the EDIT operation-indicator lights.

SAMPLES

When you select this parameter, the left side character field shows the message SAMPLES. The right side character field shows the number of samples that will be printed.

- You edit the number of samples to be printed. The lower limit is 0. The higher limit is 500. The displayed value is always the setting for the samples.
- Press **Edit** when you have finished editing.

COMMENT

When you select this parameter the left side character field shows the message COMMENT. The right side character field shows the comment string. The comment string is included so that you can identify the printout.

Note



Other applications in the same channel share the COMMENT parameter. Changing this parameter in the Print application affects the Plot application.

-
- You edit the comment using the Modify keys. There are eight characters in the comment and each of these can be a number (0 to 9), a math symbol (-, +), a space, a letter (A to Z), or punctuation symbols (!, ?, ., ,, :, ;, &, |, @,

#, \$, %, *, [,], ←, or →). The displayed characters are always the setting for the comment.

- You can press **Edit** if you have finished editing, or you can press **Next** or **Prev** to edit the other parameters.

The second page of the printout has a listing of the values of the samples from the application.

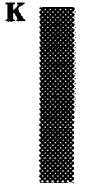



Index

1

1, 3-28

A

A/B, 2-8

Abbreviations

HP-IB Commands, 5-8

ABORT Command, 8-1, G-3

Acclimatizing Time, 2-10

acoustic noise, C-4

AC Power Source, iv, A-2

ADDRESS

Editing, 4-5

Air Circulation, A-5

Alignment Application, **3-28**

Automatic or Manual, 3-29

Changing the Range of Values, 3-30

Maximum Value, 3-29

Preparation, 3-28

Range of Values, 3-29

Running, 3-30

Tone Off, 3-31

Tone On, 3-31

Alignment Application-Parameters

Editing, 3-29

ALIGNMNT, 3-28

Application, 9-3

Continue, 1-3, 9-4

Pause, 1-3, 9-4

Selecting, 9-2

Start, 9-2, 9-4

Stop, 9-4

Application Keys, 1-3

Applications-Parameters, 2-2

Editing, 9-3

Applications-Results, 9-3

Application Status, 7-13, 9-4

A/REF, 2-8, 2-9

ATT, **2-6**

Editing, 2-6

AUTO, 2-13

AUTODUMP, 3-8, 3-11

Auto Key, 1-3, 2-12, **2-13**

Automatic Ranging, 1-3, **2-13**, 8-13

AUTOSCAL, 3-14, 3-19

Autotransformer, Using the

Instrument with an, v, A-3

AUX, **2-7**

Editing, 2-7

AVERAGE, 3-27

Averaging Status, 7-12

Averaging Time, **2-3**, 2-3, 8-13

Editing, 2-3, 8-12

B

B/A, 2-8

Bar Graph, 1-7, 2-12

Beam Diameter, Laser, vii

↓ Key, 1-2

← Key, 1-2

⇒ Key, 1-2

↑ Key, 1-2

B/REF, 2-8, 2-9

BRIGHT

- Editing, 4-7
- C**
- Cabinet, Instrument in a, iv, A-1
- CAL, **2-3**
 - Editing, 2-3
- Calibration Factor, 2-3, 8-12
 - Editing, 2-3, 8-11
- CH =, 1-6
- Chan Indicator, 1-6
- Chan Key, 1-2, **2-1**, 3-1
- Channel
 - Selected, 1-6, 2-1
 - Selecting, 1-2, 2-1
- Channel for Recall
 - Editing, 4-3
- Channel for Store
 - Editing, 4-5
- Character Field, 1-7
- Chassis Earth Connection, iv, A-1
- *CLS, **6-4**
- COMMENT, 3-15, 3-20, K-2
- Common Commands, **6-1**, 6-3, G-2
- Common Status Registers, 6-1
- Condition Register, 7-2, 7-4
- Configuration, 1-3
- Connectors
 - Electrical, A-7, A-8
 - HP-IB, A-6
 - Optical, A-7, A-8
- Contents, Damaged, A-2
- Contents, Incomplete, A-2
- Cooling, A-5
- D**
- Damage
 - Instrument, A-10
- Damage, Instrument, A-2
- Damage, Shipping Container, A-2
- DATA ?, 3-16, 3-21
- Date, 4-8, 8-27
 - Editing, 4-8, 8-27
- DATETIME, 4-7
- dB Key, 1-3, **2-8**
- dBm, 1-3, 2-9
- dBm/W Key, 1-3, **2-9**
- dB Units, 2-8
- Decimal Places
 - Number Displayed, 1-3
- Default Conditions
 - Line Power On, 1-8
- Default Mode, 1-2
- DELTA, 3-29
- DIFF, 3-27
- Display, 1-6
 - HP-IB Indicators, 5-2
 - On or Off, 8-3
- DISPLAY, 4-7
- Display Brightness, 4-7, 8-2
 - Editing, 4-7
- DISPlay Commands, 8-2, G-3
- Display Parameters
 - Editing, 4-7
- Display to Reference, 1-2, 8-18
- Disp→Ref Key, 1-2, **2-7**
- Down Key, 1-3, 2-12, **2-13**
- E**
- Editing, 1-2, 2-14
 - Selecting a Digit, 1-2, 2-14
 - Units, 2-14
- Edit Key, 1-3
- Electrical Noise
 - Compensating for, 1-3
- Enable Register, 7-2, 7-5
- Error, 8-27
- Error Messages, 1-1
 - HP-IB, 1-3
 - Instrument, 1-1
- Error Queue, 6-3
- *ESE, 6-5
- *ESE?, 6-6

- *ESR?, 6-6
- Event Register, 7-2, 7-5
- Event Status Enable, 6-5
- Event Status Enable Register, 6-1, 6-6
- Event Status Register, 6-1, 6-6

F

- FETCh Command, 8-4, G-3
- Fuse, iv, A-2
- Fuse, Changing the, iv, A-2

H

- HHMMSS
 - Editing, 4-8
- HP 8152A Compatability, H-1
- HP 8152A Compatibility, 4-6, 5-3
- HP-IB, 5-1
 - References, 5-1
- HPIB, 4-5
- HP-IB Address, 5-8
 - Default, 5-8
 - Editing, 4-5
- HP-IB Bus Commands, 5-4, G-1
- HP-IB Cable, A-6
- HP-IB Capabilities, 5-2, G-1
- HP-IB Command Abbreviations, 5-8
- HP-IB Connector, A-6
- HP-IB Language, 5-3
 - Editing, 4-6
- HP-IB Mode
 - Editing, 4-6
- HP-IB Network, A-5
- HP-IB Parameters
 - Editing, 4-5
- HP-IB Signal Levels, A-7
- Humidity
 - Operating, A-5

I

- *IDN?, 6-7
- IEEE-488, 6-1
 - Reference, 5-1
- Initial Inspection, A-2
- INITiate Commands, 8-7, G-3
- Input Signals, vi, A-5
- Instrument Identification, 6-7

K

- Key
 - Functions, 1-2
- Keyboard, 1-2
- Keys
 - Black, 1-2
 - Blue, 1-3

L

- LANGUAGE
 - Editing, 4-6
- Laser
 - Adjustment, viii
 - Enabling, viii
 - Malfunctioning, viii
 - Output Connector, viii
- Laser Beam Diameter, vii
- Laser Class, vii
- Laser Diode Current, 7-17, 7-18
- Laser Monitor Current, 7-18
- Laser Numerical Aperture, vii
- Laser Output Power, vii
- Laser Radiation, viii
- Laser Safety, vii
 - Warning Labels, vii
- Laser Type, vii
- Laser Wavelength, vii
- Line Power Cable, iv, A-2
- Line Power Consumption, iv, A-2
- Line Power, Disconnection from, iv, A-1
- Line Power On, 1-8

- Default Conditions, 1-8
 - Line Power Plug
 - Changing, vi, A-4
 - Color Coding, vi, A-4
 - Requirements, vi, A-4
 - Line Power Socket, v, A-3
 - Line Power Source, AC, iv, A-2
 - LOBATT, 1-6
 - Local Key, 2-1
 - Local Lockout, 5-2, 5-4, 9-1
 - Location for Recall
 - Editing, 4-3
 - Location for Store
 - Editing, 4-5
 - LOGGING, 3-9
 - Logging Application, 1-11, **3-9**, 3-14, 3-18, 3-27, 9-5, K-2
 - Automatic Plot, 3-11
 - Automatic Printout, 3-11
 - Number of Samples, 3-10
 - Preparation, 3-6
 - Running, 3-12
 - Start Conditions, 3-12
 - Start Threshold, 3-12
 - Logging Application-Parameters
 - Editing, 3-10, 9-5
 - Logging Application-Results, 9-6
 - LOSS, 3-3
 - Loss Application, **3-2**
 - Changing the Device Under Test, 3-4
 - Preparation, 3-2
 - Results, 3-4
 - Running, 3-3
 - Loss Key, 1-3, **3-2**
 - Loss Measurement, 3-2
- M**
- MAN LOGG, 3-13
 - Manual Logging Application, **3-13**, 3-14, 3-18, 3-27, K-2
 - Preparation, 3-6
 - Running, 3-13
 - Manual Ranging, 1-3, 2-13
 - Master Summary Status Bit, 6-13
 - MAV Bit, 6-3
 - MAXIMUM, 3-27
 - MAXPOWER, 3-29
 - Measurement Command, 5-3, 8-4, 8-8
 - Setting, 8-9
 - Measurement-Parameters, 3-2, 3-6, 3-9, 3-12, 3-28
 - Default Values, 2-2
 - Editing, 2-2
 - Selecting, 2-2
 - Measurement Parameters, 1-2
 - Measurement Range
 - Higher, 1-3
 - Lower, 1-3
 - Measure Mode, 1-2, **2-1**, F-1
 - Keys, 1-2
 - Selecting, 3-1, 4-1
 - Measuring Status, 7-11
 - Menu Mode, 1-3, **3-1**, F-2
 - Keys, 1-3
 - Selecting, 2-1
 - Message Available Bit, 6-3
 - MINIMUM, 3-27
 - MinMax Application
 - Running, 3-26
 - MM/DD/YY
 - Editing, 4-8
 - Mode
 - Selected, 1-6
 - Selecting, 1-2, 2-1, 3-1
 - MODE
 - Editing, 4-6
 - MODE=, 1-6
 - Mode Indicator, 1-6
 - Mode Key, 1-2, **2-1**, 3-1, 4-1
 - Modify Keys, 1-2, **2-14**

- Module
 - Fitting, A-8
 - Removing, A-7
 - Module Identification, 6-9
 - Module Type for Recall
 - Editing, 4-3
 - Module Type for Store
 - Editing, 4-5
 - More Applications
 - Selecting, 1-4, 3-26
 - More Key, 1-4, **3-26**
 - MSS Bit, 6-13
 - Multi-Mode Cable, 2-10
- N**
- N Dig Key, 1-3, **2-11**
 - Next Key, 1-3, 3-6, 3-8, 3-9, 3-10, 3-12, 3-14, 3-26, 3-29, 4-2
 - NO DATA, 3-16, 3-21
 - Node
 - Status Registers, 7-1
 - NR1, 5-10
 - NR2, 5-10
 - NR3, 5-11
 - NRf, 5-11
 - Numerical Aperture, Laser, vii
- O**
- *OPC, 5-3, **6-8**
 - *OPC?, 5-3, 6-9
 - Operating Environment, 2-9, A-4
 - Acclimatization, 2-10
 - Operating Humidity, A-5
 - Operating Temperature, 7-18, A-5
 - Operation Indicator, 1-7
 - *OPT?, 6-9
 - Optical Cable, viii
 - Outdoor Use, vi, A-4
 - Output Connector, Laser, viii
 - Output Power, Laser, vii
 - Output Queue, 6-3
 - Output Signals, vi, A-5
- P**
- PARAM=, 1-7
 - Parameter Indicator, 1-7
 - Parameters
 - Editing, 2-14
 - Measurement, 1-2
 - Param Key, 1-2, **2-2**
 - Parser, 5-3
 - Accepted Characters, 5-4
 - Operation, 5-3
 - Synchronisation, 5-3
 - Parser Input Queue, 6-3
 - Clearing, 5-4
 - Pause Key, 1-3
 - Performance Tests, A-2
 - Plot
 - Automatic Scaling, 3-14
 - PLOT, 3-14
 - Plot Application, 1-13, 3-8, 3-11, **3-14**
 - Preparation, 3-6, 3-14
 - Running, 3-16
 - The Plot, 3-16
 - Y Axis Maximum, 3-15
 - Y Axis Minimum, 3-15
 - Plot Application-Parameters
 - Editing, 3-14
 - Plot Identification
 - Comment Text, 3-15
 - Plotter, 3-6, 3-14
 - Power Measurement, 1-9
 - Power Reading Over Range, 7-17
 - Prev Key, 1-3, 3-6, 3-8, 3-9, 3-10, 3-12, 3-14, 3-26, 3-29, 4-2
 - PRINT, 3-18, K-2
 - Print Application, 3-8, 3-11, **3-18**, K-2
 - Automatic Scaling, 3-19
 - Comment Text, 3-20, K-2

- Preparation, 3-6
- Running, 3-21
- Samples to Print, K-2
- The Printout, 3-21
- Y Axis Maximum, 3-20
- Y Axis Minimum, 3-19
- Print Application-Parameters
 - Editing, 3-19, K-2
- Printer, 3-6
- PROGram Commands, 9-1, G-4
- Protective Earth, iv, v, A-2, A-3
- Protective Earth, Interrupting, v, A-3
- Protective Earth Symbol, iv, A-1

R

- Range, 1-3, **2-11**, 2-13, 8-14, 8-16
 - Displaying, 2-12
- Range Keys, **2-11**
- READ Command, 8-8, G-5
- Recall, **4-2**
- Recall Parameters
 - Editing, 4-2
- Record Application, 3-5
- Record Applications
 - Selecting, 1-3, **3-6**
- Record Key, 1-3, **3-5**
- REF, **2-5**
 - Editing, 2-5
- Reference, 2-5, 8-17, 8-19, 8-20
 - Display to, 1-2, 2-7, 8-18
 - Editing, 2-5, 8-16
 - Other Channel as, 2-8, 8-20
 - Relative to, 2-8
 - Results Relative to, 1-3, 8-19
 - Setting, 1-2, 2-7
- Reference Indicator, 1-7
- Remote Control
 - Local Key, 2-1
- Repacking, A-10
- Request Service, 6-3

- Reset, 6-10
- Reset State, 6-10
- Result Field, 1-7, 2 11
- Return Shipments, A-10
- RMT, 1-6, 5-2
- RQS, 6-3
- *RST, 6-10

S

- Safety Class, iv, A 1
- Sales and Service Offices, J-1
- Samples
 - Average Value, 3-17, 3-23, 3-27
 - Examining, 3-13, 3-27, 3-28
 - Maximum Value, 3-17, 3-23, 3-27
 - Minimum Value, 3-17, 3-23, 3-27
 - Range of Values, 3-17, 3-23, 3-27
 - Take Again, 3 13
- SAMPLES, 3-10, K 2
- SCPI, 5-6
 - Syntax, 5-6
- SELFTEST, 1-8
- Self-Test Command, 6-14
- SENSE Commands, 8-9, G-5
- Serial Poll, 6-3
- Service Request, 6-3
- Service Request Enable Register, 6-11, 6-12
- Setting, Instrument
 - Recalling, 4-2
- Settling
 - Peltier, 7-11
- SHOW, 3-27
- Show Application, 1-12, **3-27**
- Signals
 - Input, vi, A-5
 - Output, vi, A-5
- Source
 - On or Off, 7-21, 8-24, 8-25
- Source Attenuation, **2-6**, 8-24
 - Editing, 2-6, 8-24

- SOURce Commands, 8-22, G-6
 - Source Modulation, **2-7**, 8-23
 - Editing, 2-7, 8-23
 - Specifications, C-1
 - *SRE, 6-11
 - *SRE?, 6-12
 - SRQ, 1-6, 5-2, 6-3
 - Stability Application, **3-7**, 3-14, 3-18, 3-27, 9-6, K-2
 - Automatic Plot, 3-8
 - Automatic Printout, 3-8
 - Preparation, 3-6
 - Running, 3-9
 - Total Time, 3-8
 - Stability Application-Parameters
 - Editing, 3-8, 9-6
 - Stability Application-Results, 9-6
 - STABILTY, 3-7
 - Standard Setting, 4-3
 - Recalling, 1-8, 4-2
 - START, 3-12
 - Status
 - Error, 7-13, 7-16, 7-19
 - Operational, 7-7, 7-10
 - Questionable, 7-13, 7-16
 - Source, 7-20
 - Status Byte Register, 6-1, 6-13
 - STATus Command, 6-13, 7-3
 - Status Registers, 6-4, 7-1
 - Clearing, 6-4
 - Common, 6-1
 - Setting, 7-3
 - Status Request Enable Register, 6-1
 - *STB?, 6-13
 - Storage, A-9
 - STORE, **4-4**
 - Store Parameters
 - Editing, 4-4
 - Syntax Diagram
 - Conventions, 5-9
 - SYSTEM Commands, 8-26, G-9
 - System Key, 1-3, 3-2, **4-2**
 - System Mode, **4-1**, F-3
 - Selecting, 3-2
 - System-Parameters
 - Selecting, 1-3
 - System Parameter-Sets
 - Selecting, 4-2
- T**
- T, 2-3**
 - Editing, 2-3
 - Talk Only, 1-13
 - Temperature
 - Cooling, A-5
 - Operating, A-5
 - Storage, A-9
 - Temperature Changes, A-5
 - THRESHLD, 3-12
 - Time, 4-8, 8-29
 - Editing, 4-8, 8-28
 - TLK ONLY, 1-6, 5-2
 - TMSL, 4-6, 5-6
 - Syntax, 5-6
 - Transition Filter
 - Negative, 7-2, 7-6
 - Positive, 7-2, 7-6, 7-7
 - *TRG, 6-14
 - Trigger
 - Continuous, 8-4, 8-7
 - Immediate, 8-4, 8-7, 8-8
 - Trigger Command, 5-3, 6-14, 8-1, 8-7
 - Trigger Status, 7-12
 - *TST?, 6-14
 - T-TOTAL, 3-8
 - Two Sensor Instrument, 2-8
 - TYPE, 3-29
- U**
- Units, 8-21
 - Selecting, 1-3, 8-21
 - Up Key, 1-3, 2-12, **2-13**

W

- *WAI, 5-3, **6-14**
- Wait Command, 6-14
- Warm-Up Time, 2-10
- Watts, 1-3, 2-9
 - Editing, 2-14
- Wavelength, **2-2**, 8-26
 - Editing, 2-2, 8-21, 8-22, 8-25
 - Laser, vii

Y

- Y_MAX, 3-15, 3-20
- Y_MIN, 3-15, 3-19

Z

- ZERO ERR, 2-10
- Zeroing, 1-3, 1-9, **2-9**, 5-3, 8-11
- Zeroing Error, 2-10
- Zero Key, 1-3, **2-9**
- Zero Status, 7-12